

FORT VANCOUVER



COLORING BOOK

Words chosen by Tracy Fortmann
Illustrated by Jane Vanderzanden

Dear Colorer:

Everyone likes to color and read. We here at Fort Vancouver like to do both! We hope you will enjoy learning about Fort Vancouver through this book.

Fort Vancouver is a very special place. People (adults and kids) come from all over the world to visit. If you haven't come here, please come and see us. If you have, come back! This is your national park — an exciting and interesting place.

If you want to learn more, please call our visitor center to find out about tours, special events, and other fun things you and your family can do, at (360) 816-6230 or go to www.nps.gov/fova.

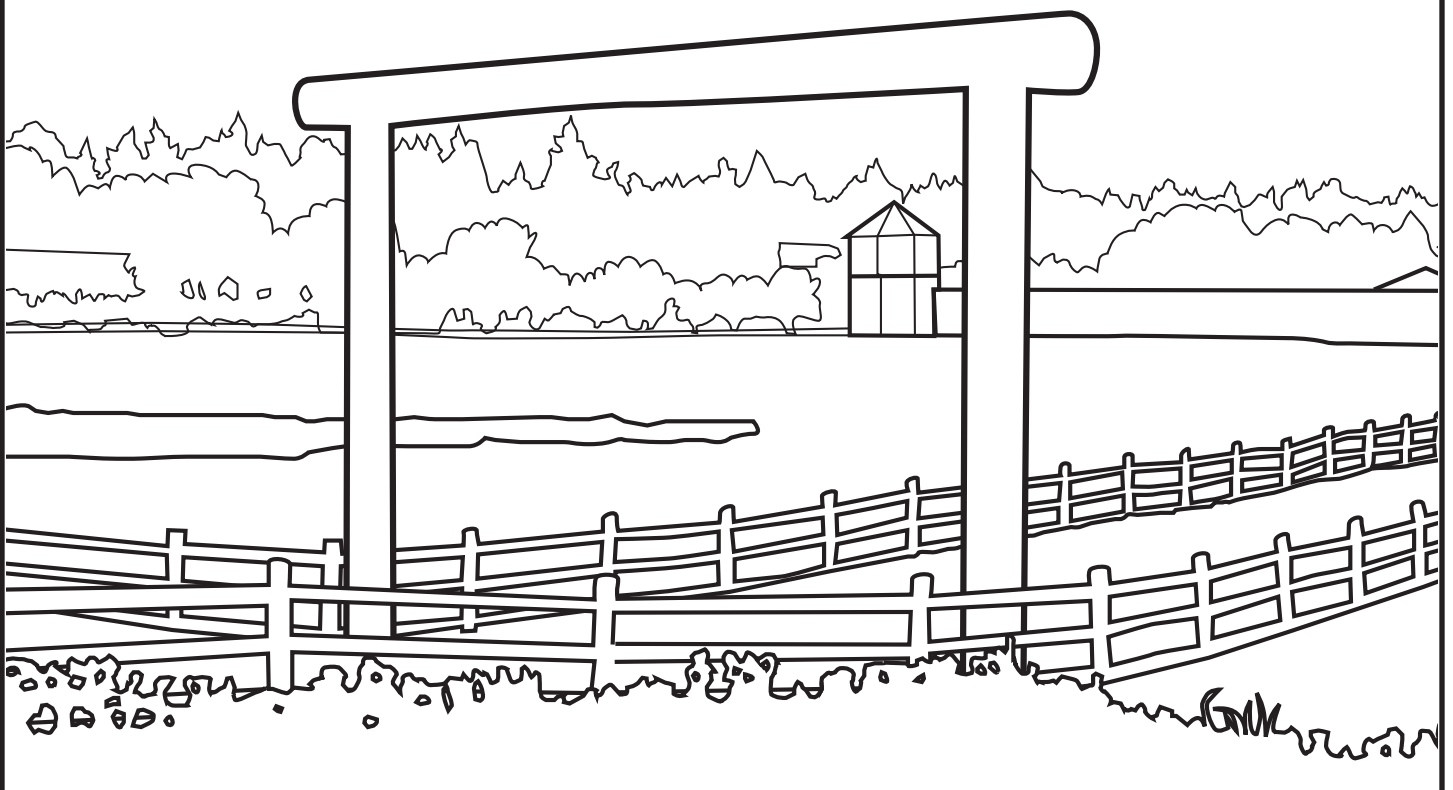

A

is for

Apples

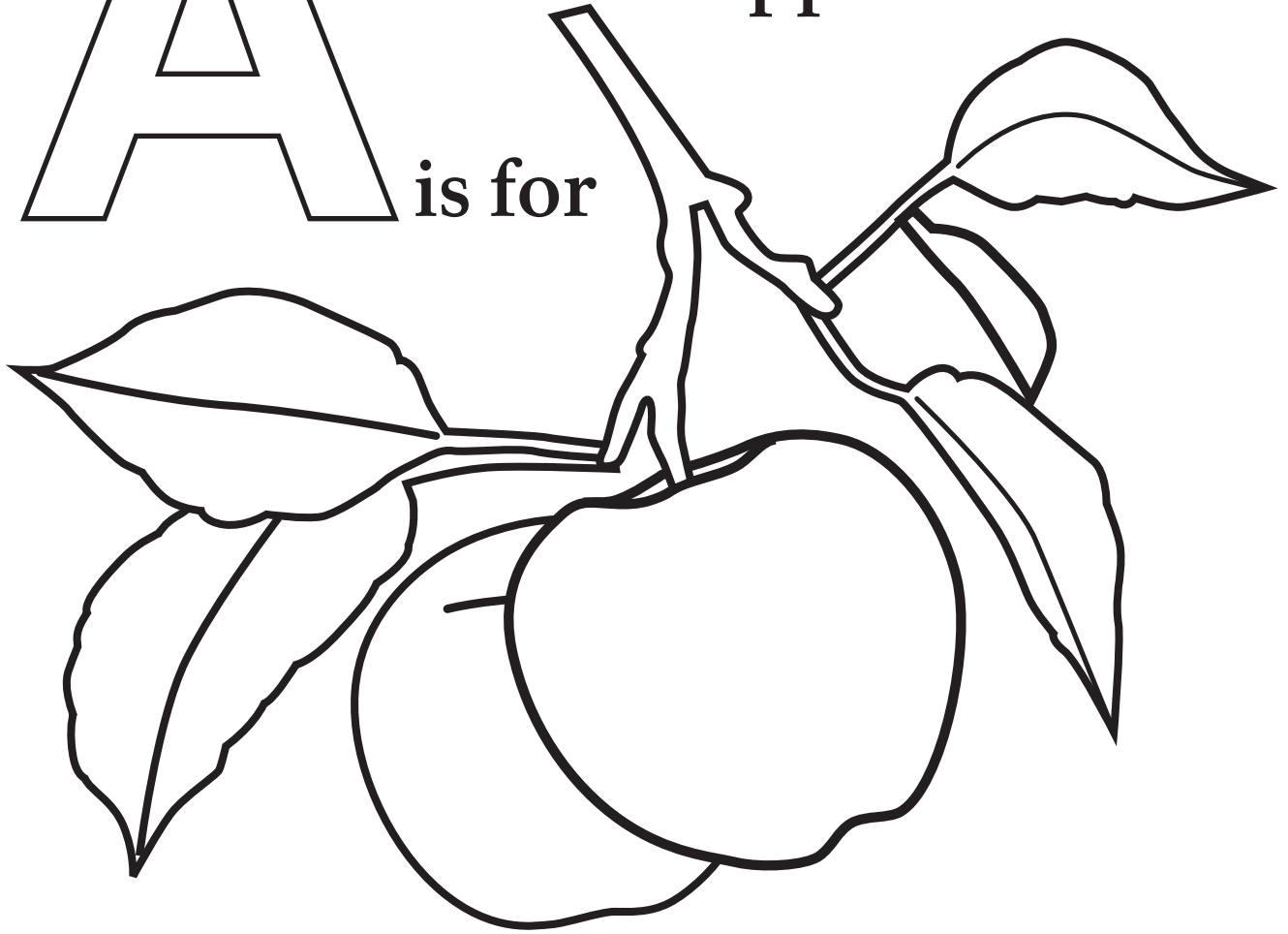

Apple Trees

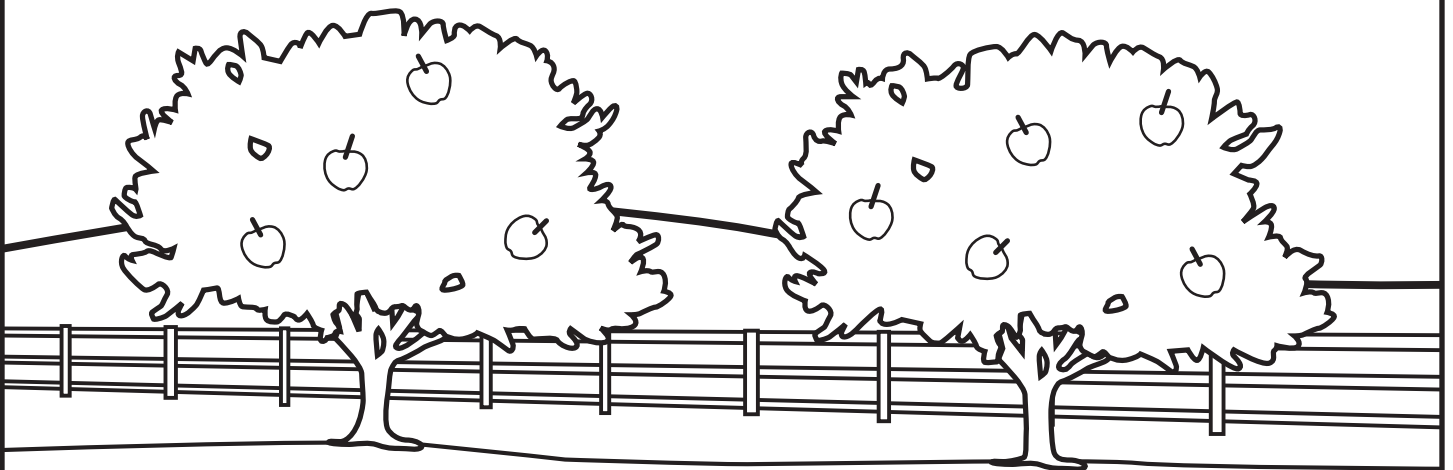

Artifacts

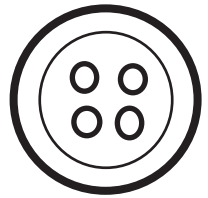
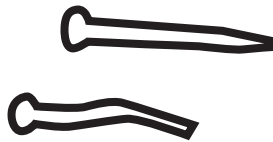
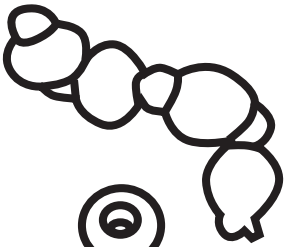
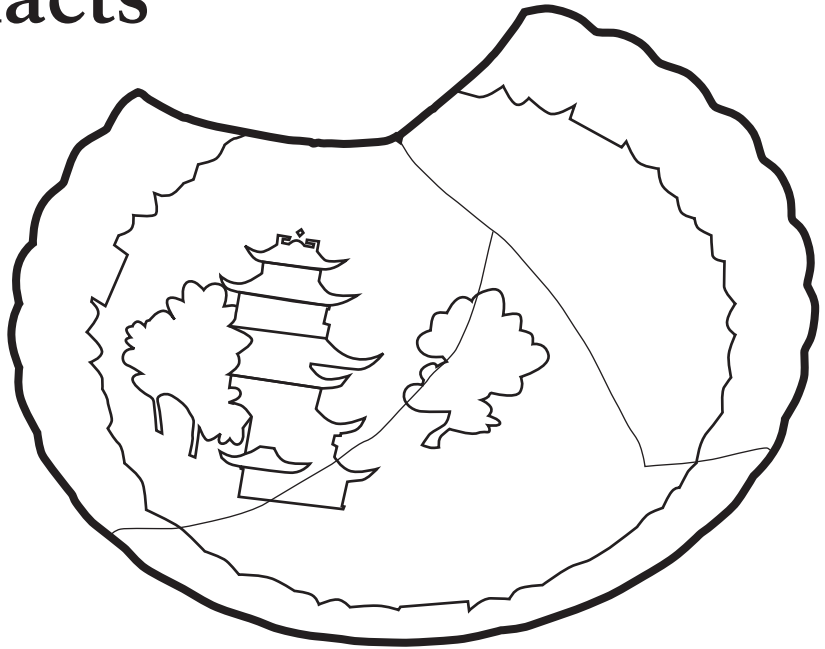

Arrowhead

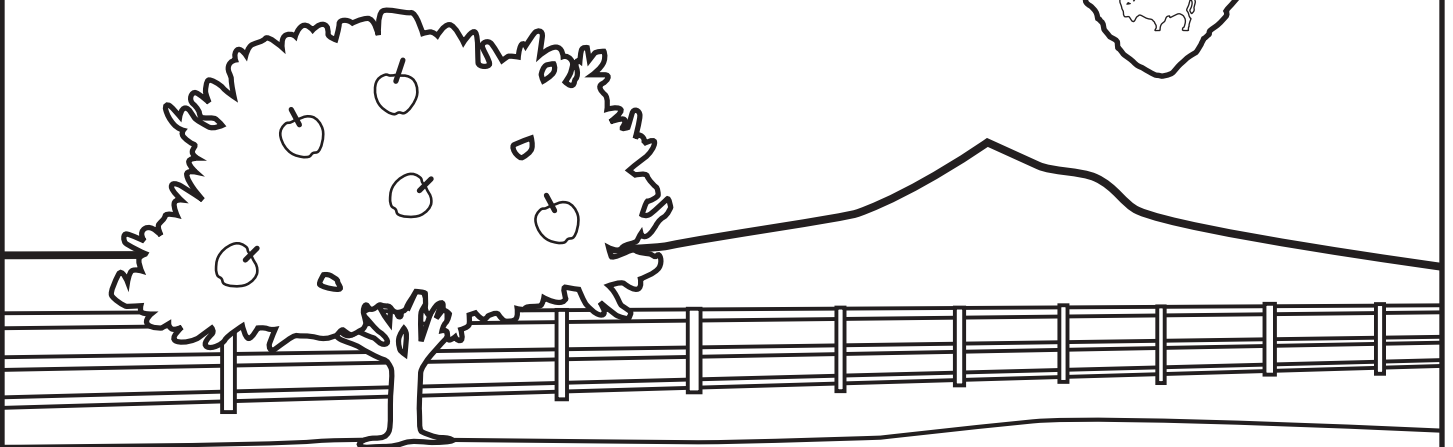

B

is for

Basket

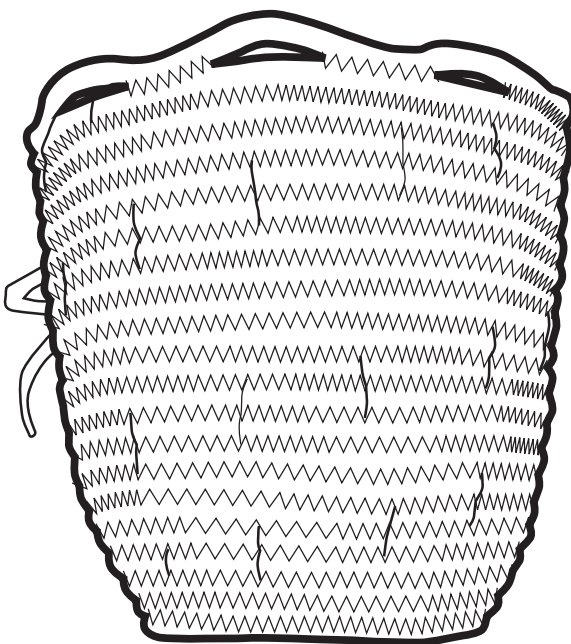

Bastion

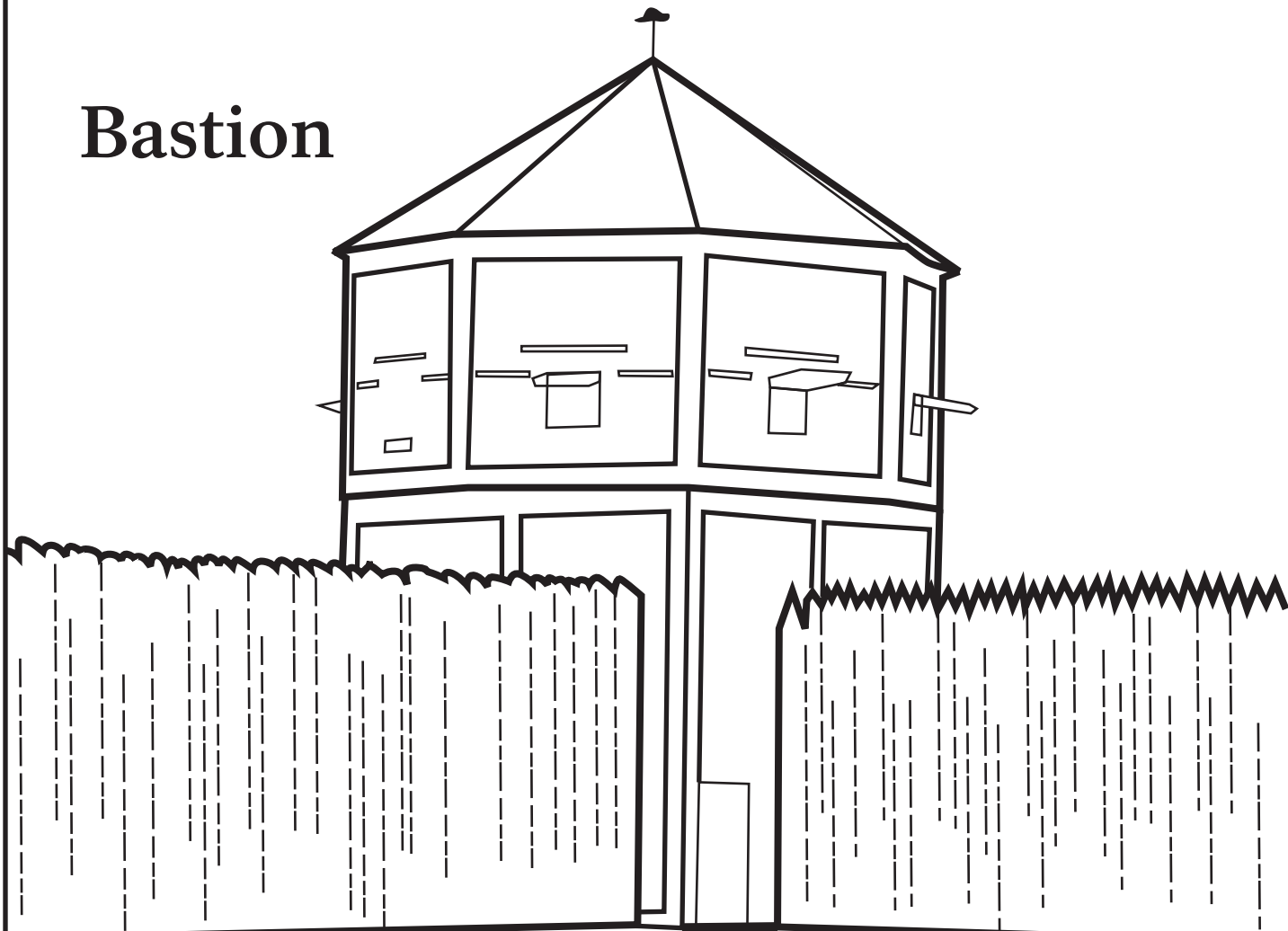

Beaver

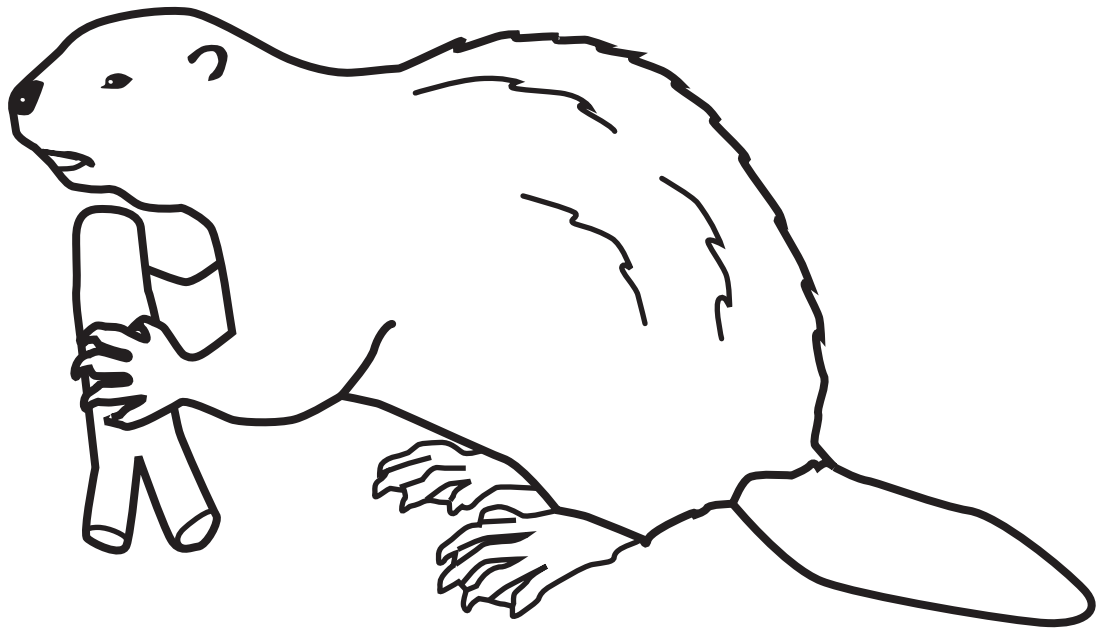

Barracks



C

is for

Canoe

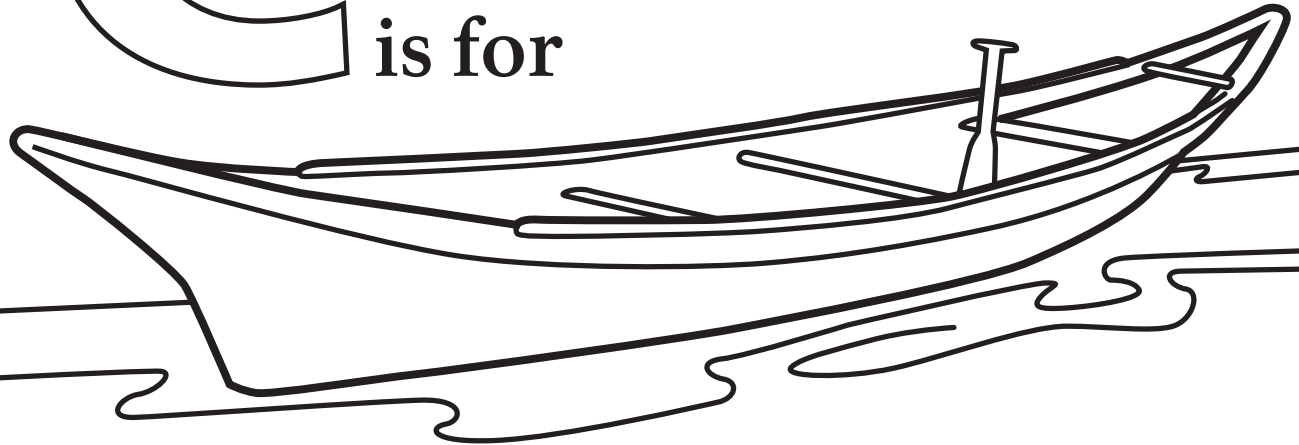

Camas

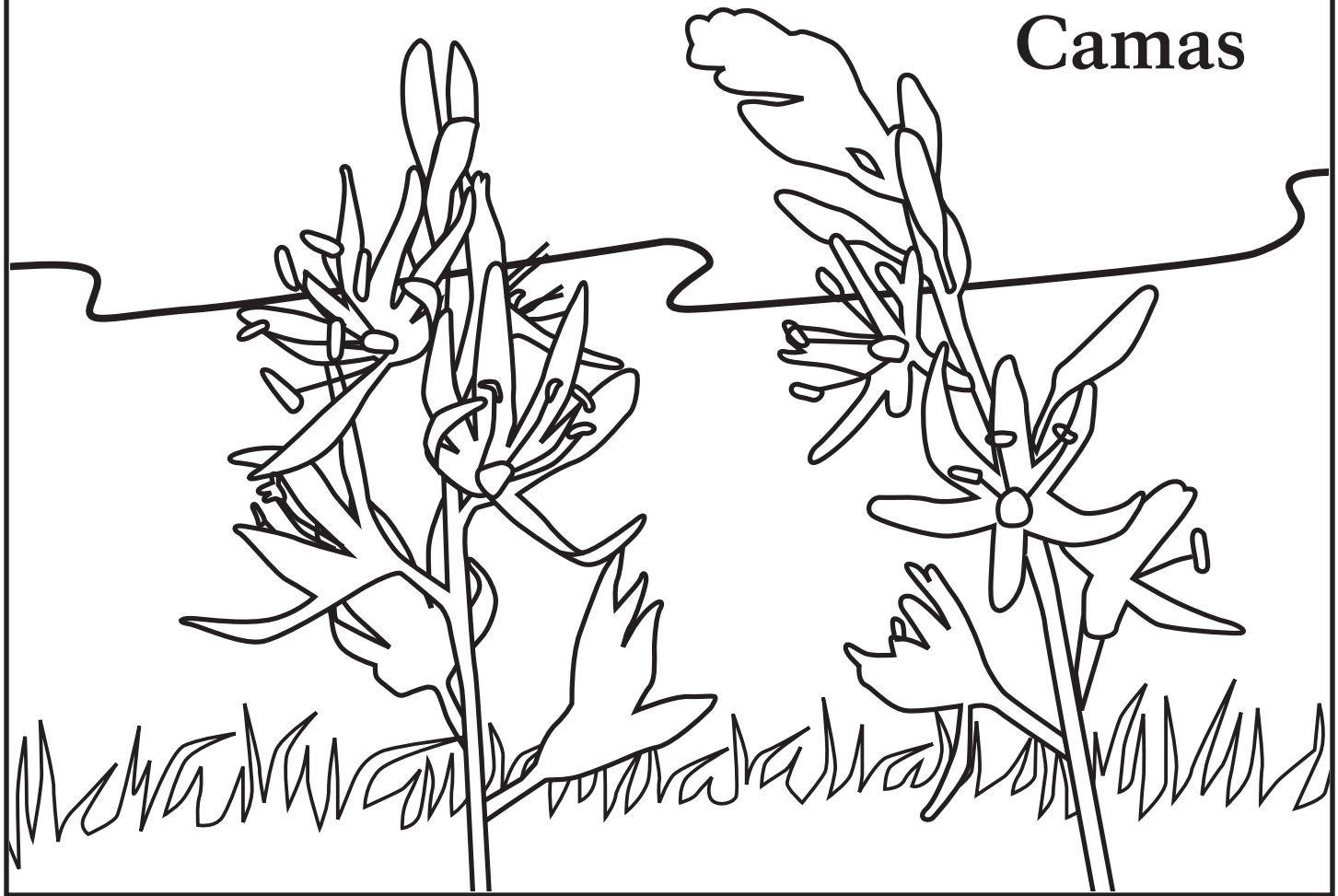

Cannon

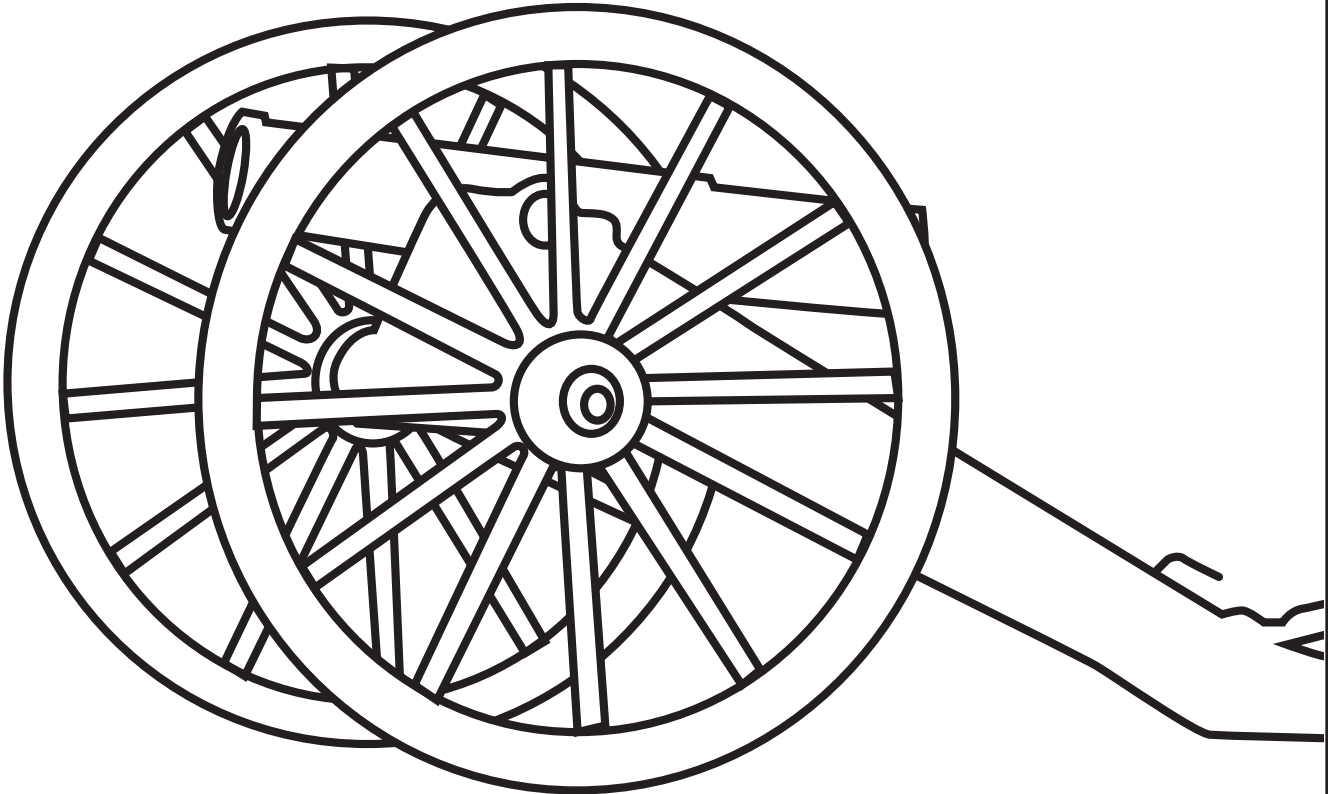

Cows



D

is for

Doll

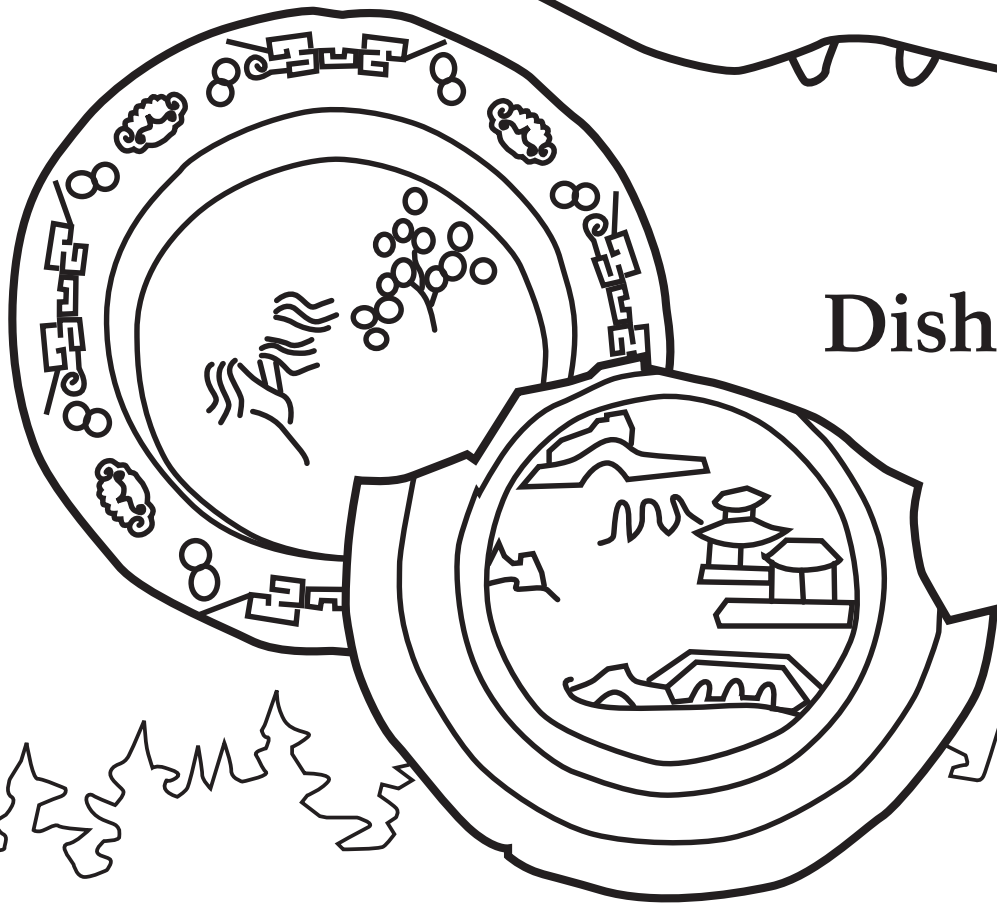
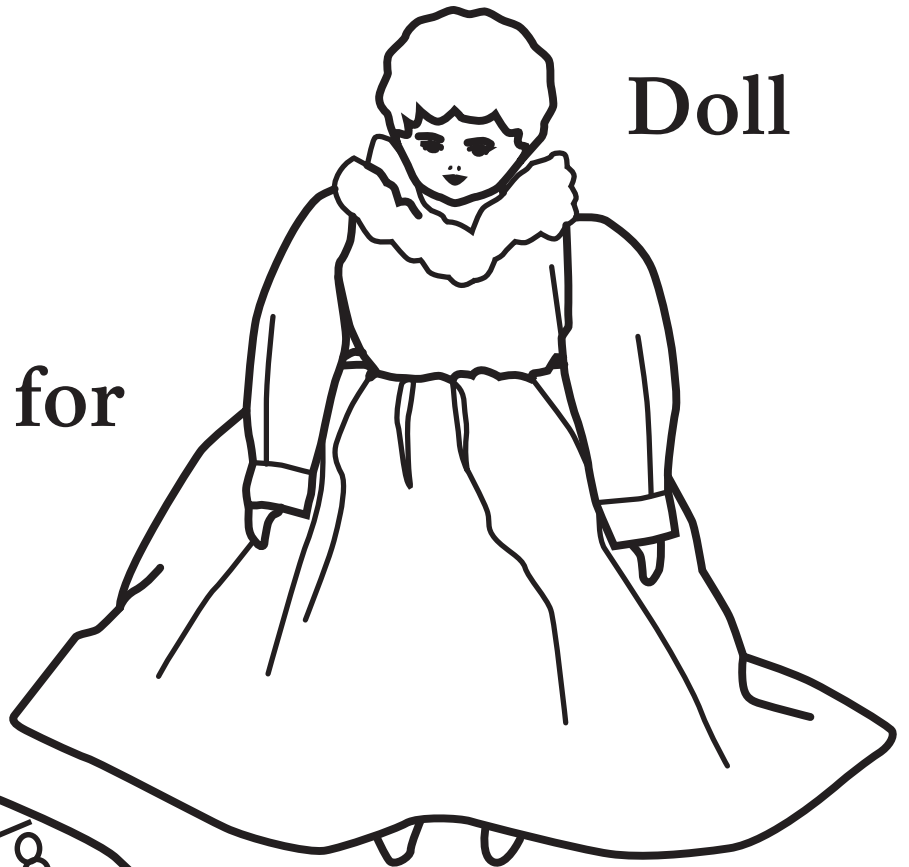

Dishes

Douglas
Fir



Dress



Deer

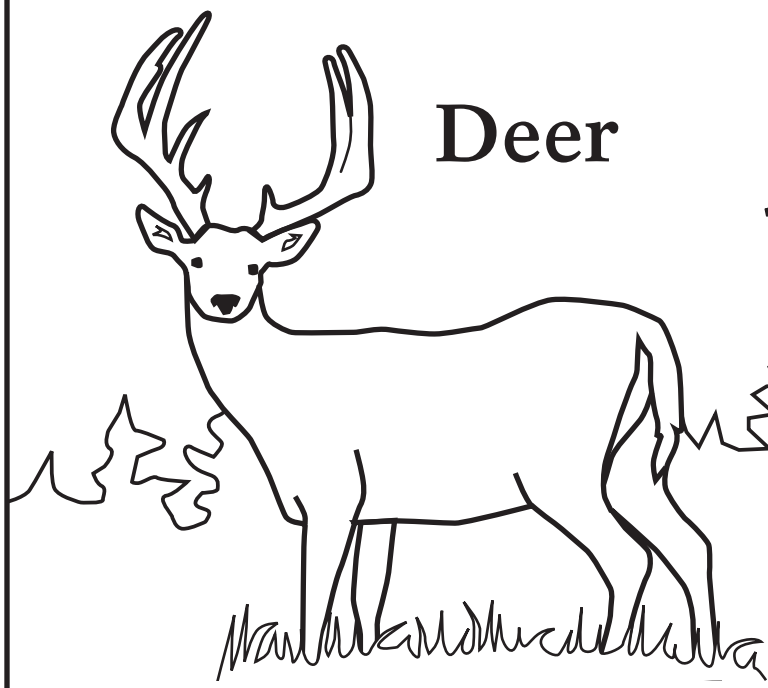

E

is for

Eagle

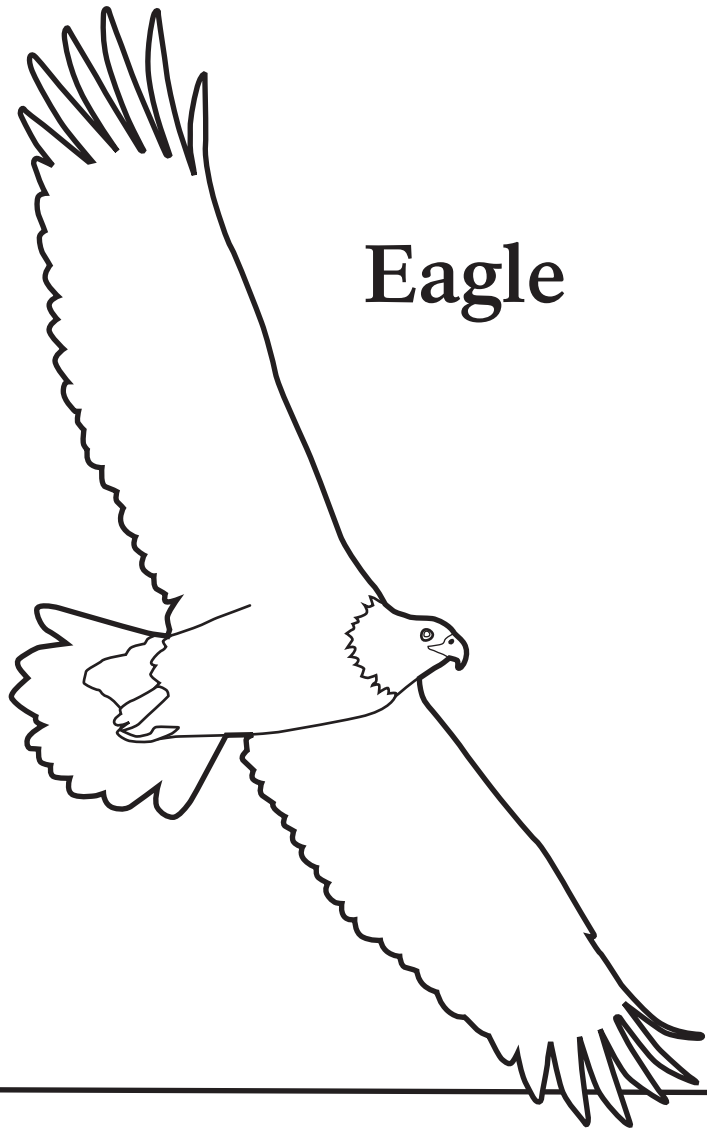

Excavation

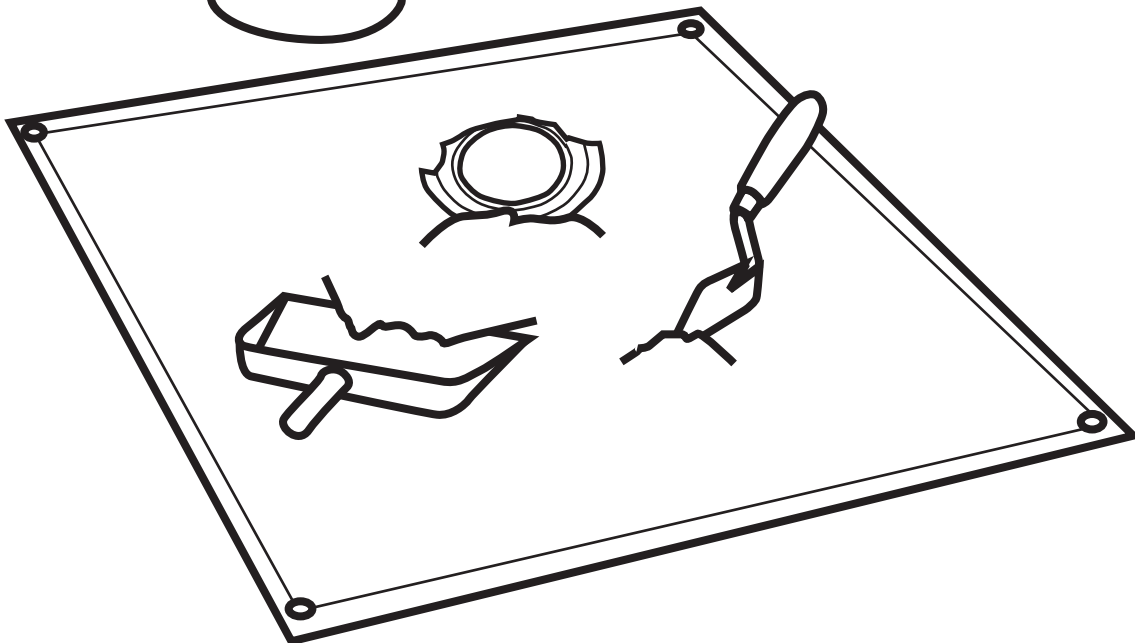
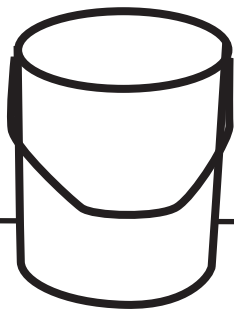

Emblem

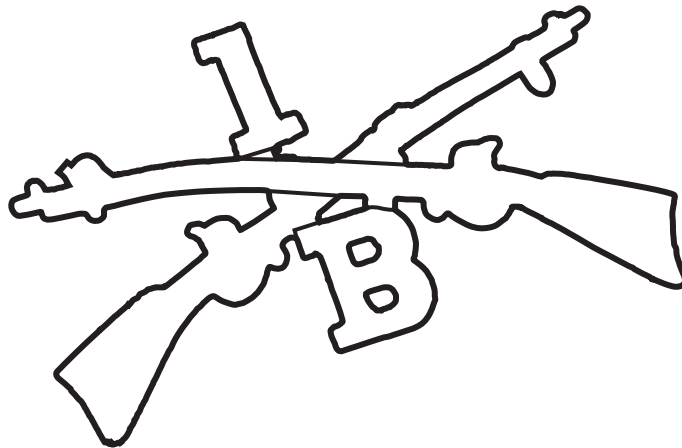

Encampment

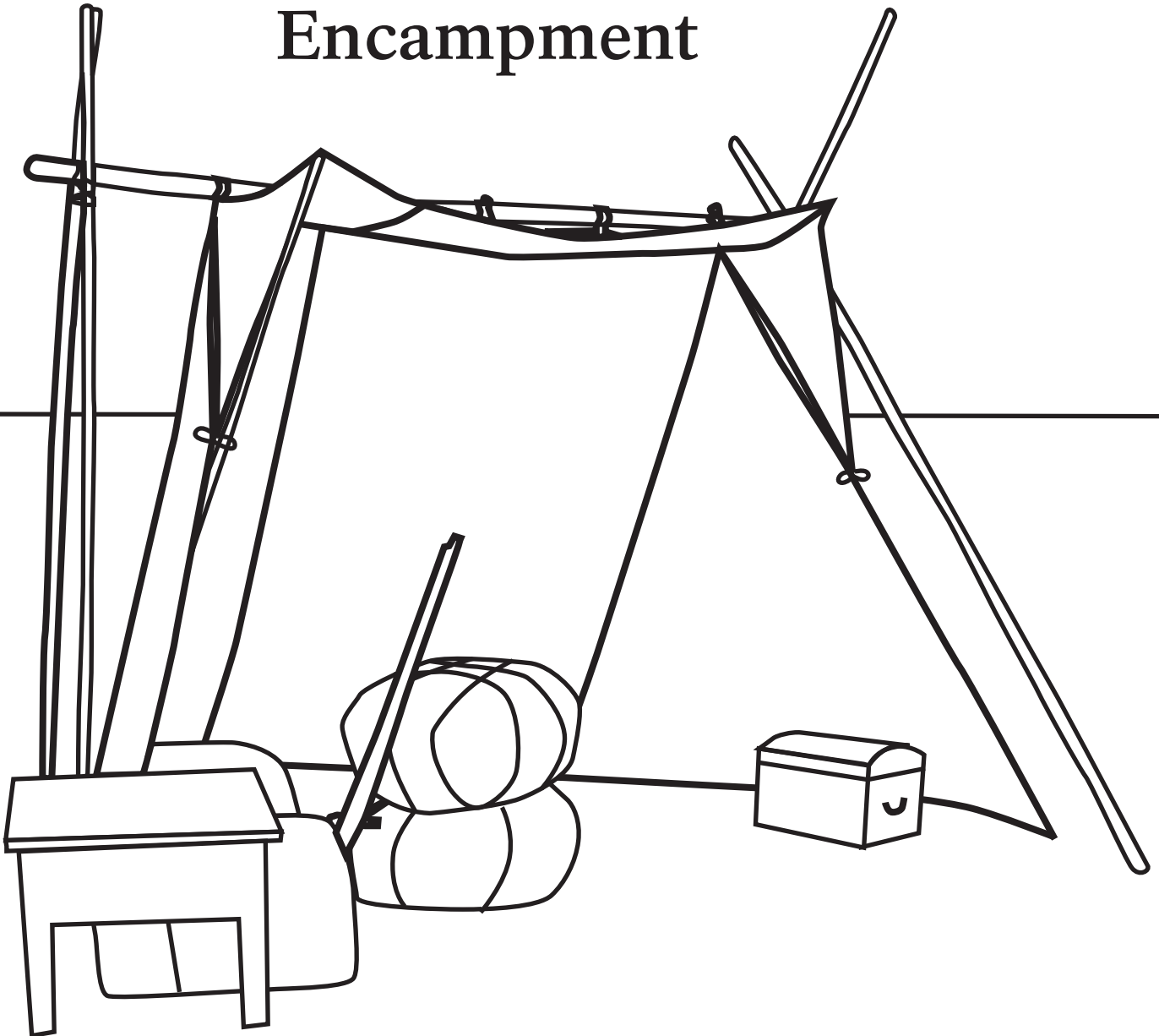

F

is for

Feather

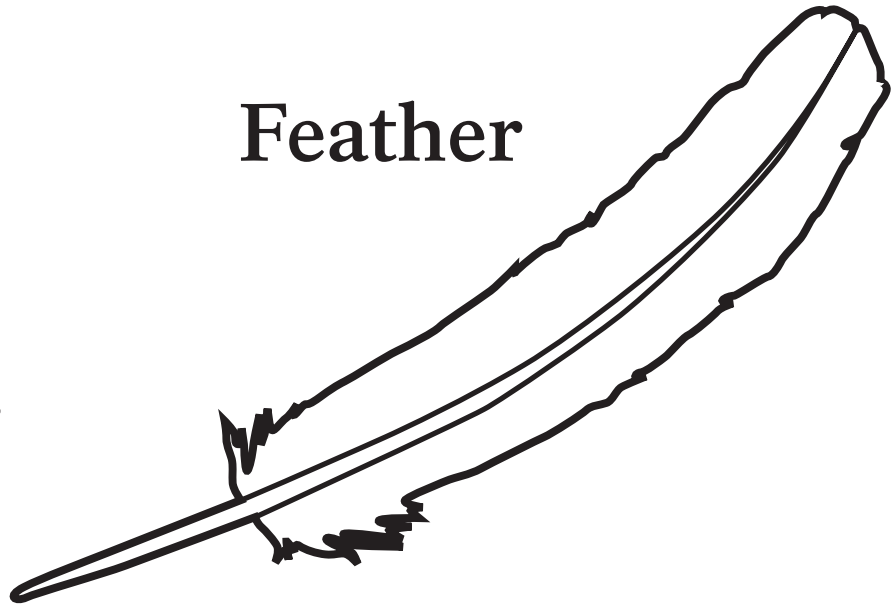

Furs

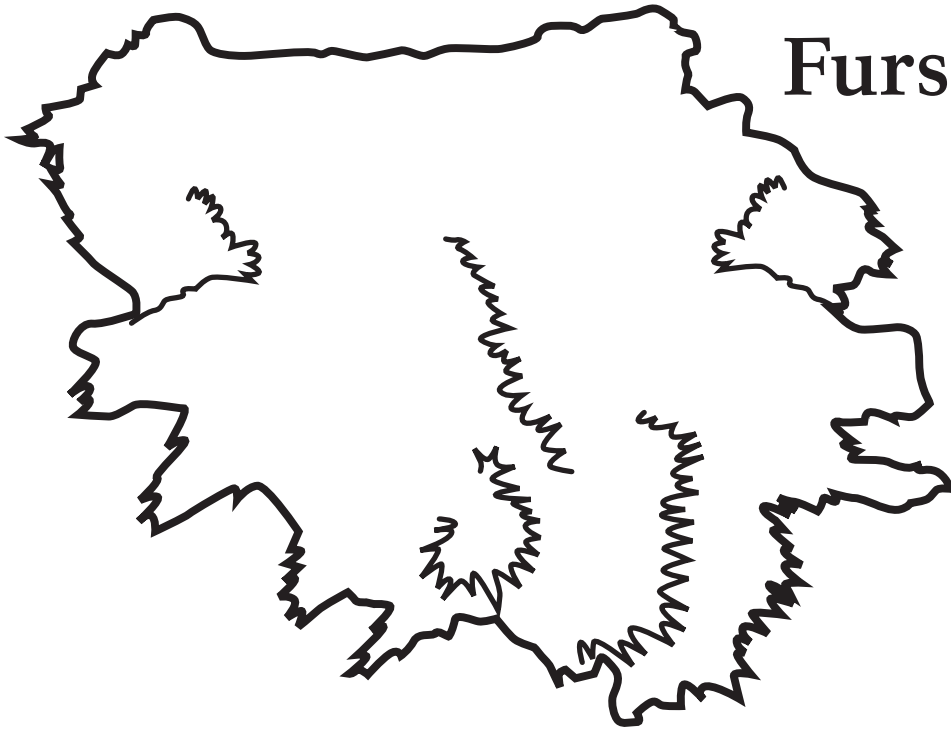

Fort Vancouver

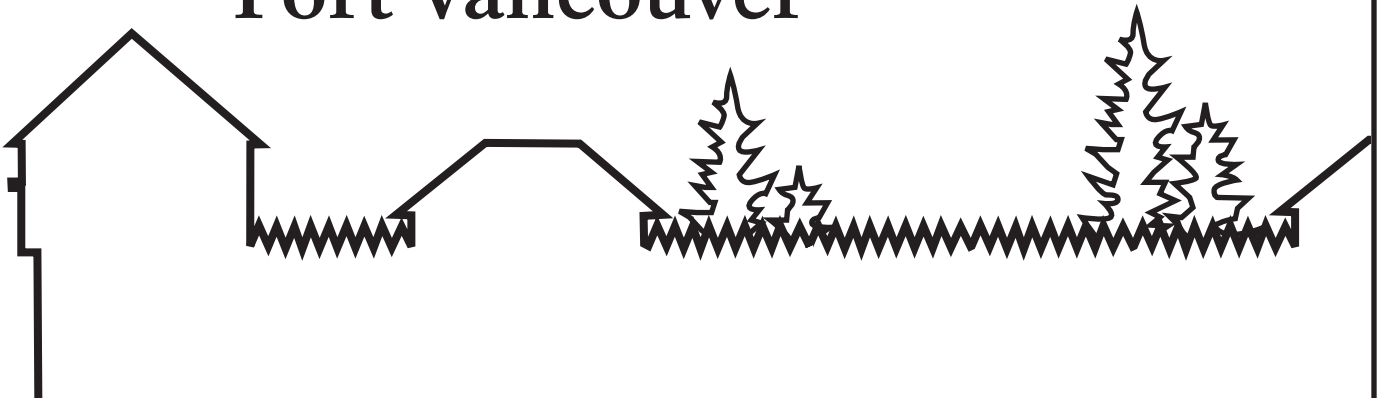

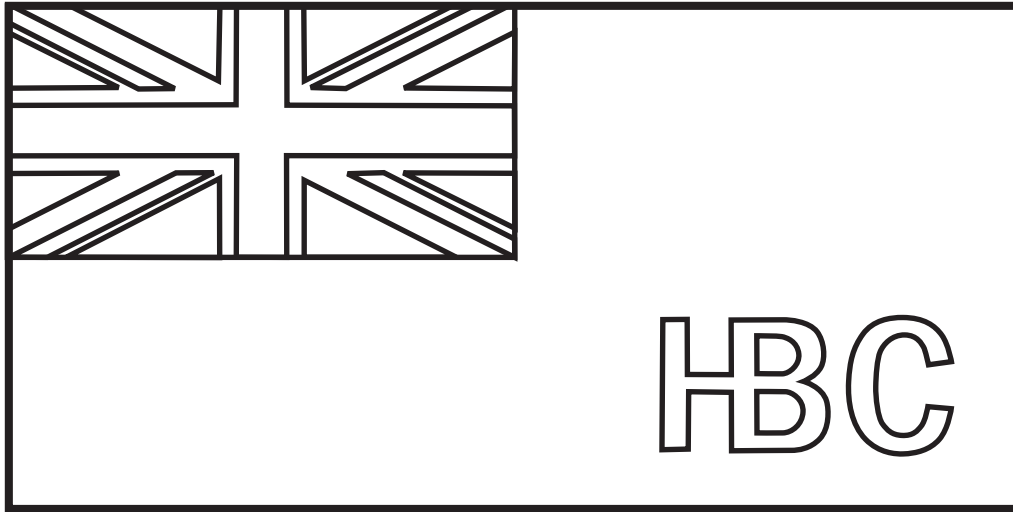
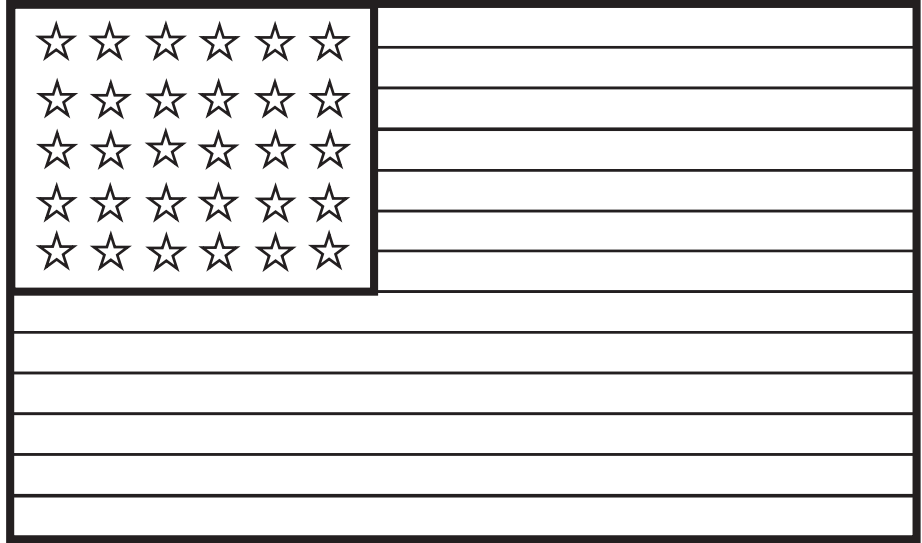

Flags

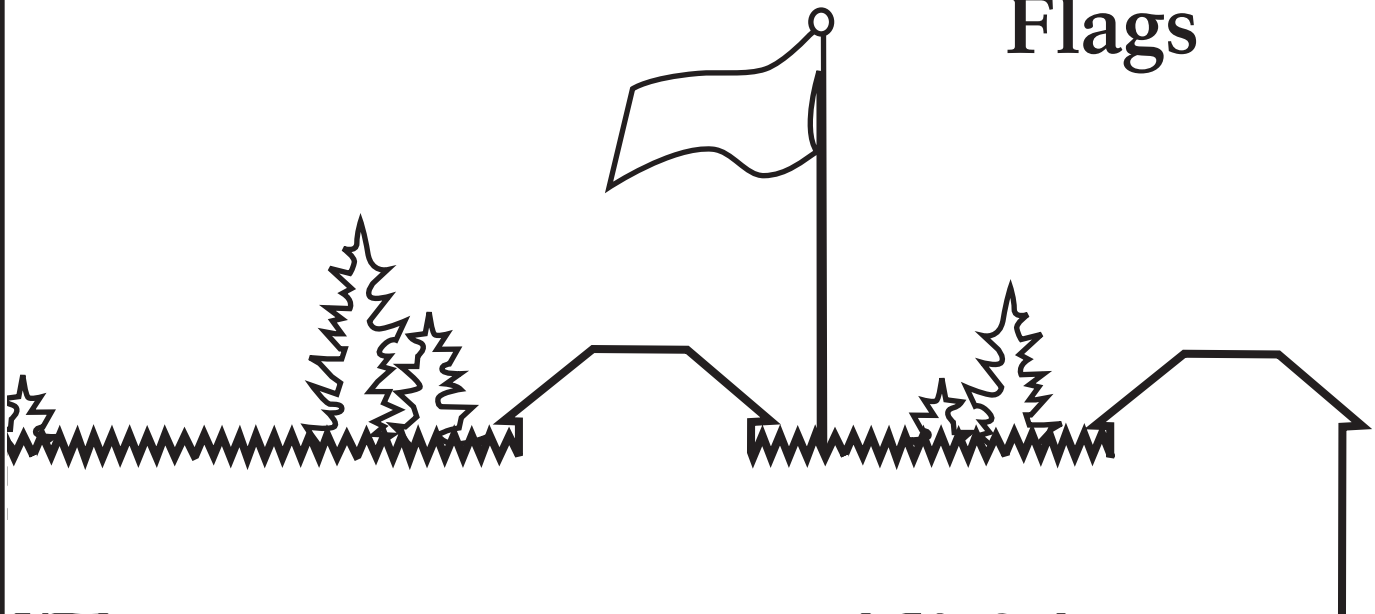

G

is for

Garments



Garden

Pumpkin



Tomato



Potato



Gun

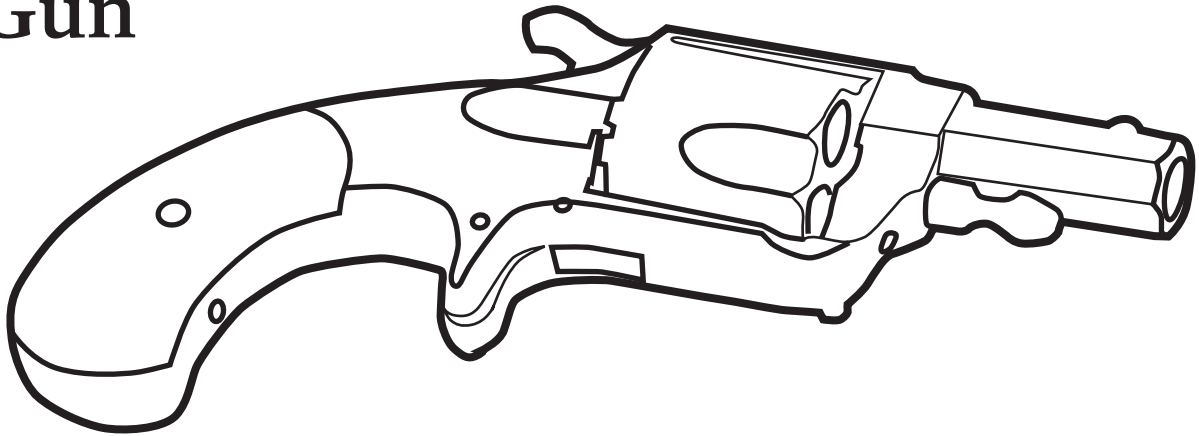

Geese

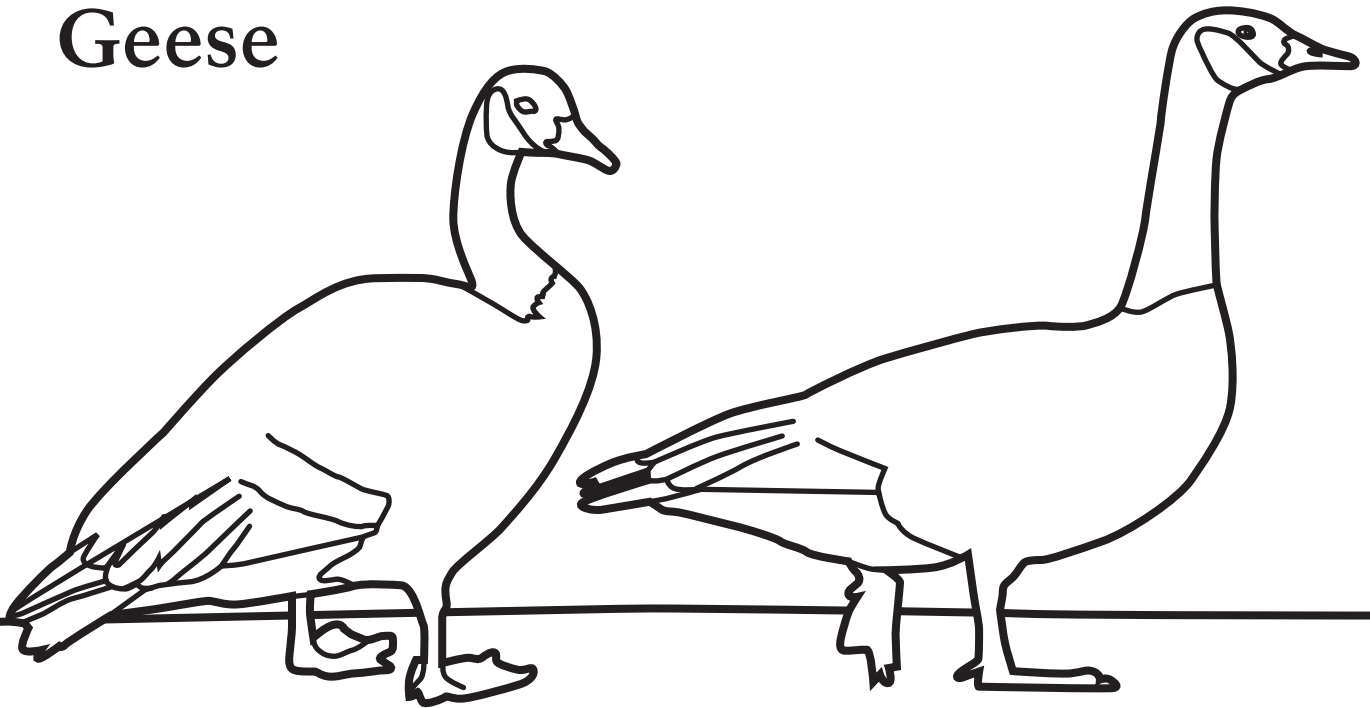

H

Hudsons Bay Blanket

is for

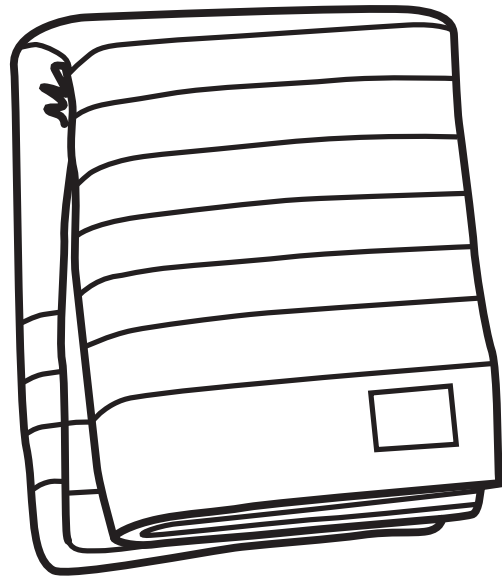

House



Horses

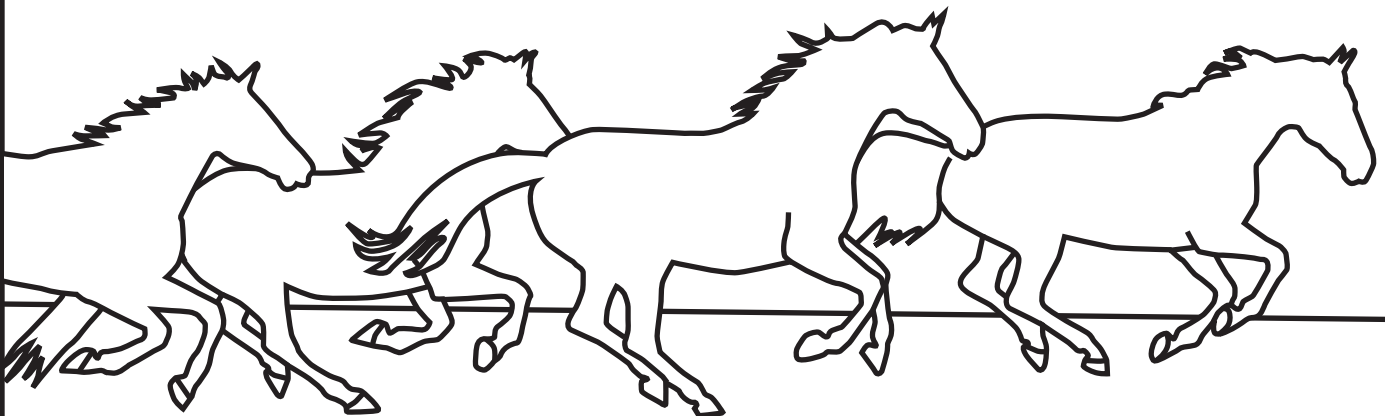

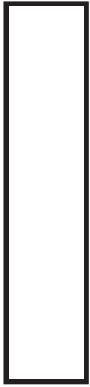

is for

Idaho

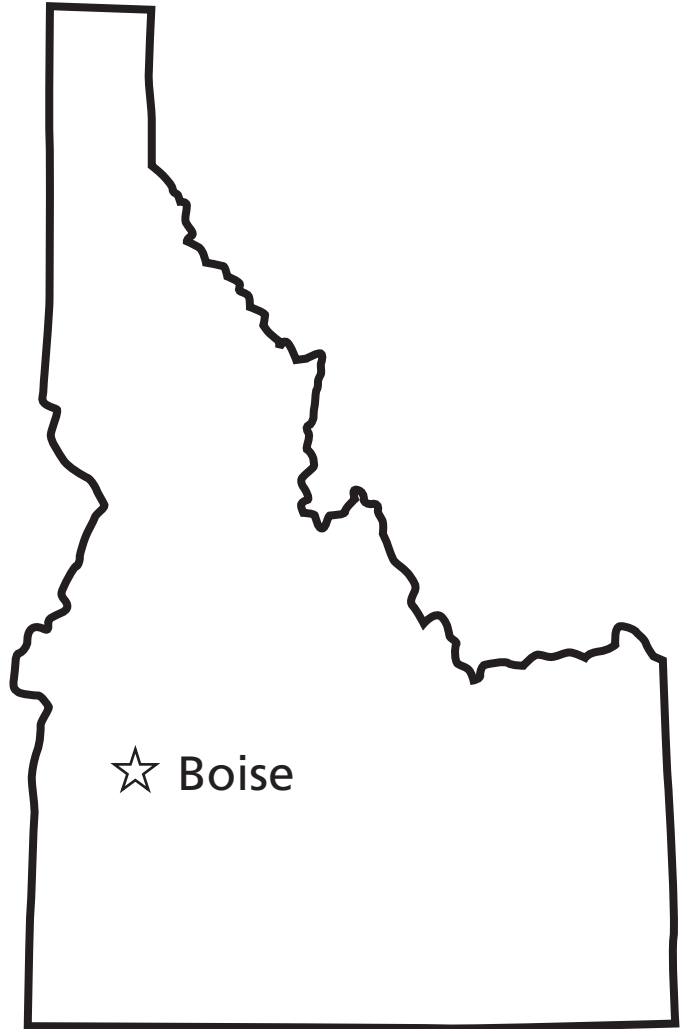

Indian
Trade Shop

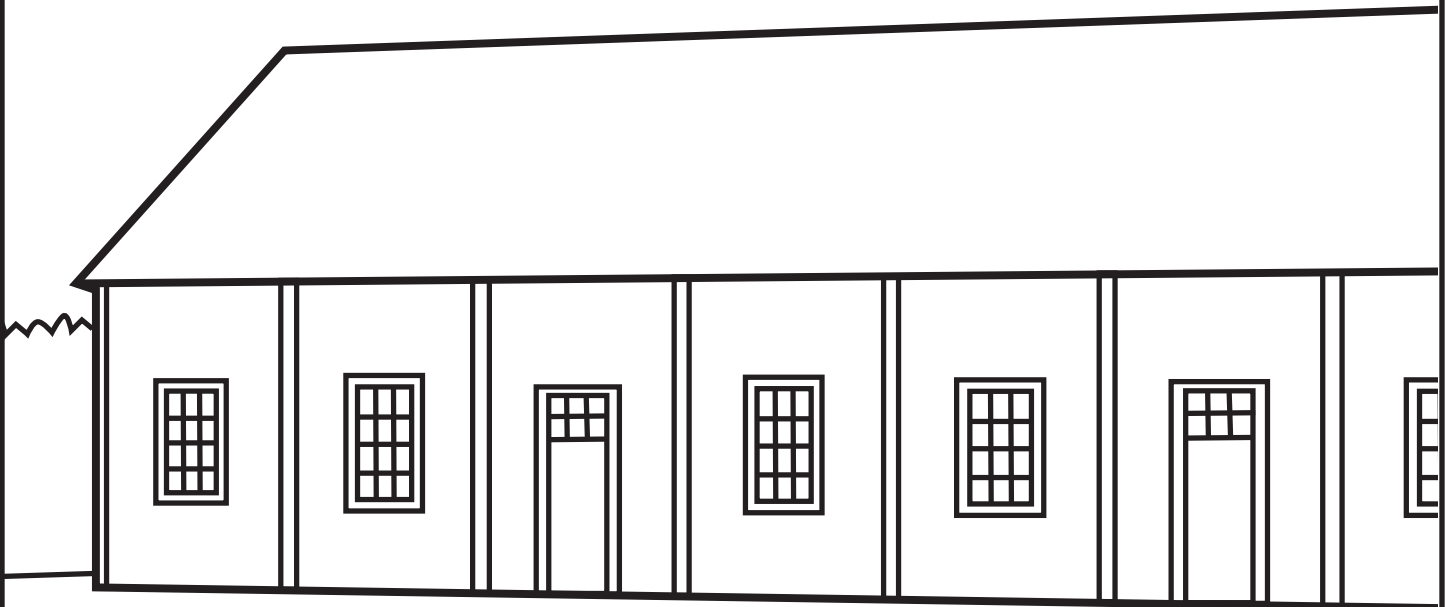

J

Japanese
Teapot

is for

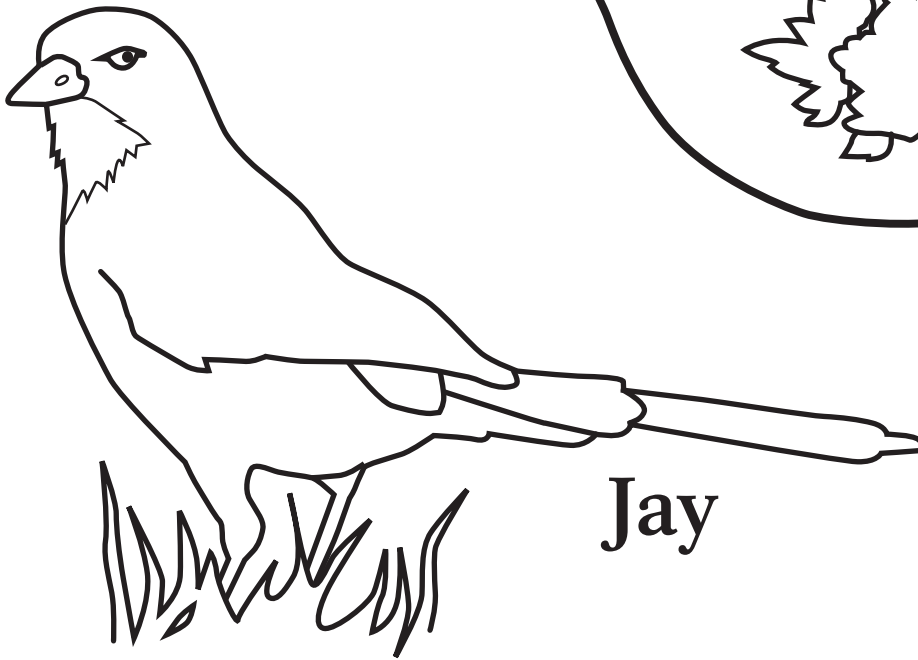
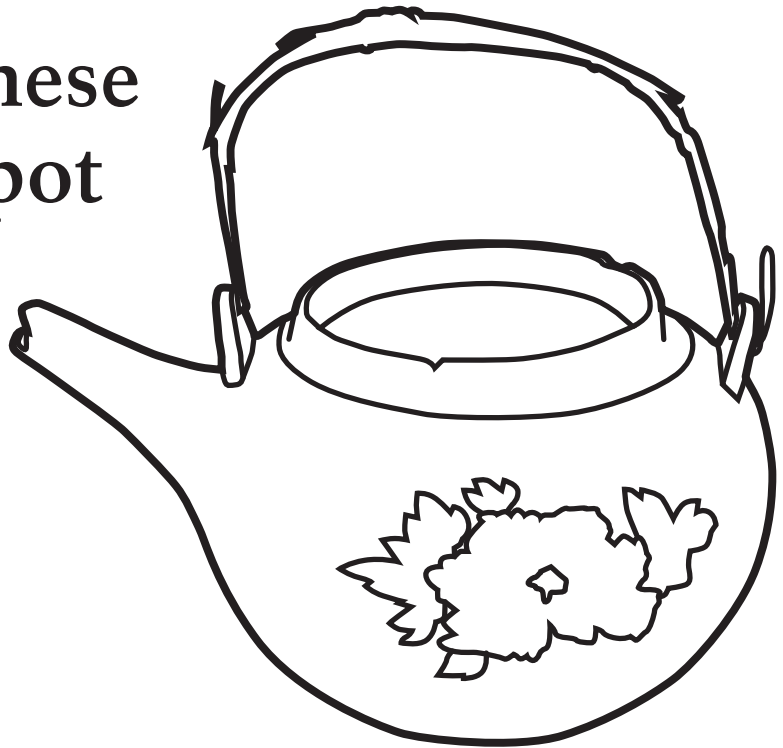

Jay

Jail



K

is for

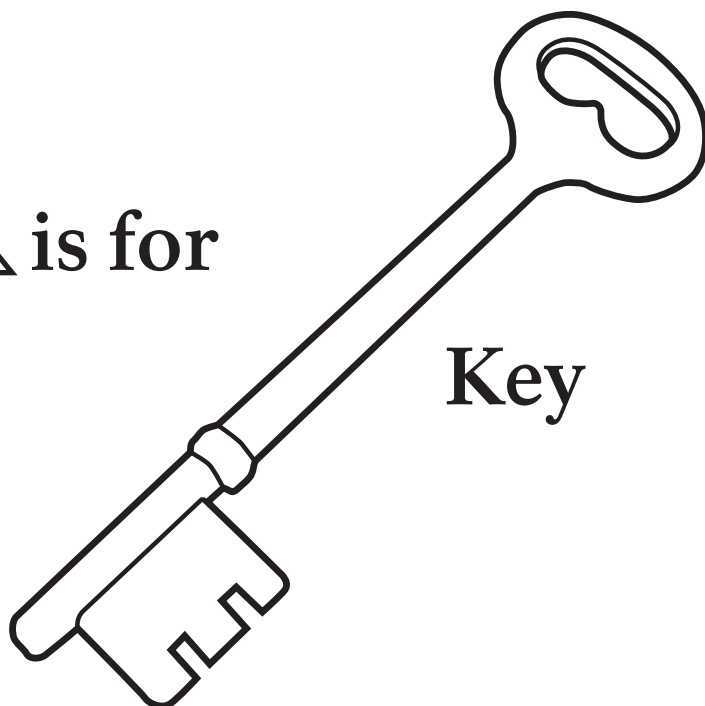

Key

Kitchen

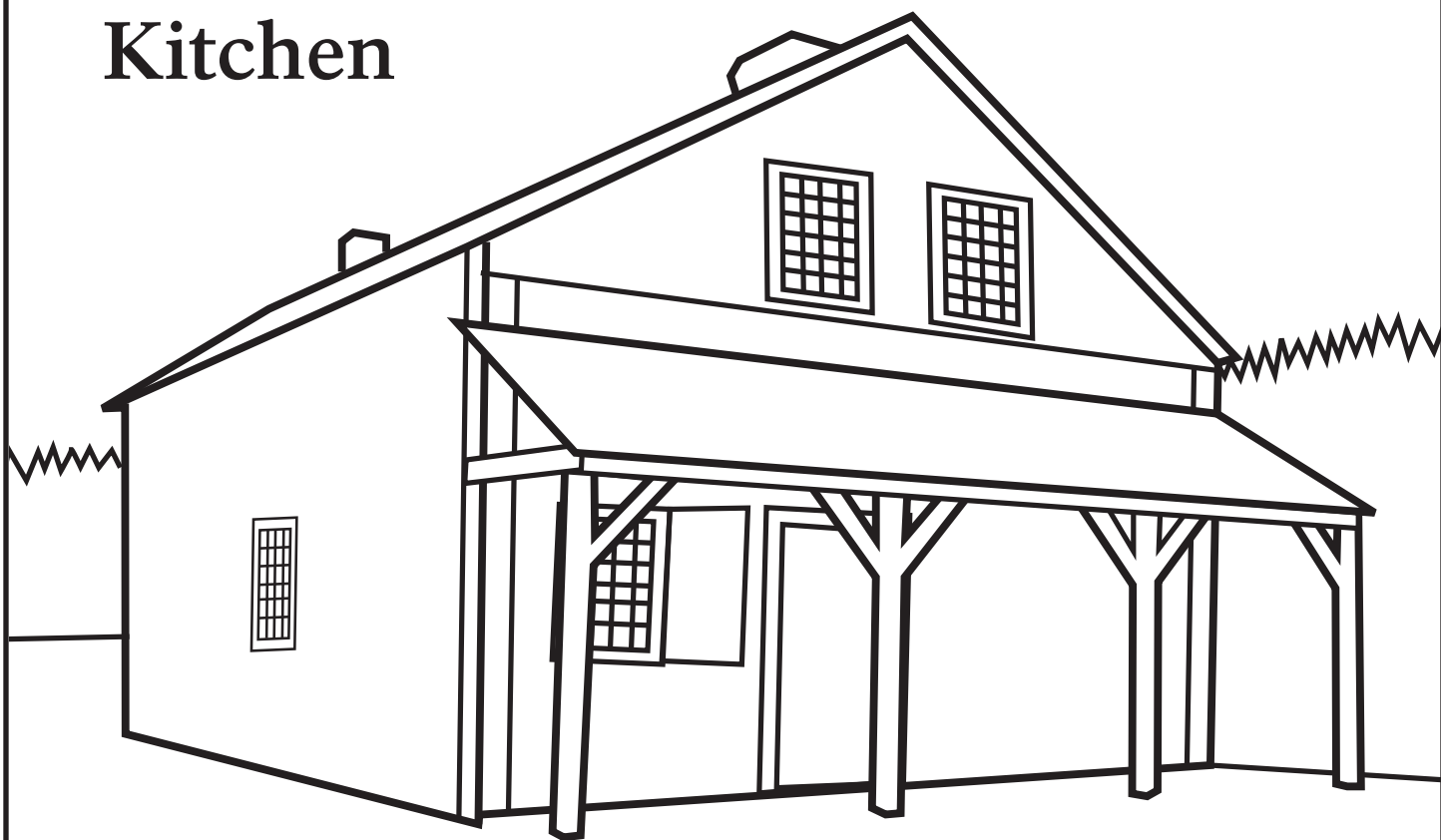

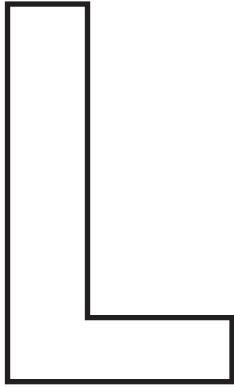

is for

Lantern

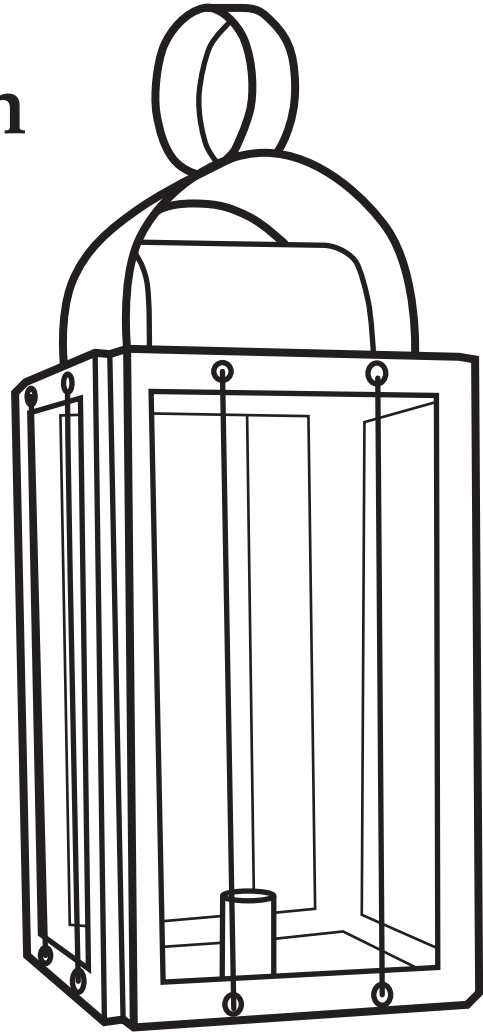

Leaf

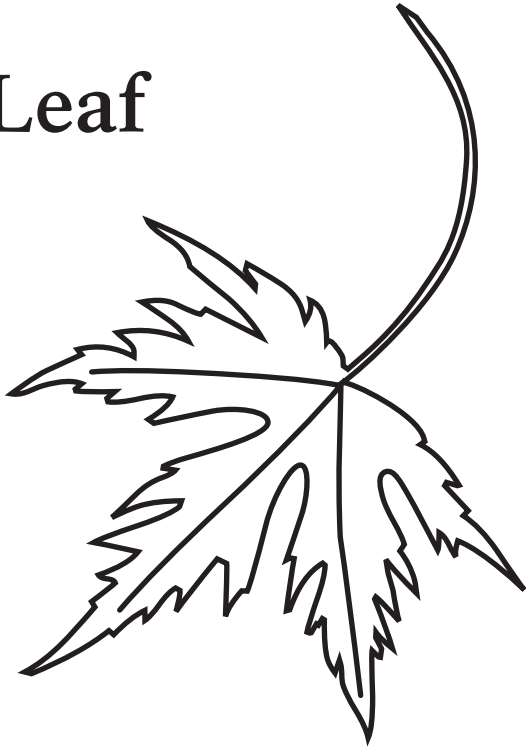

Land Bridge

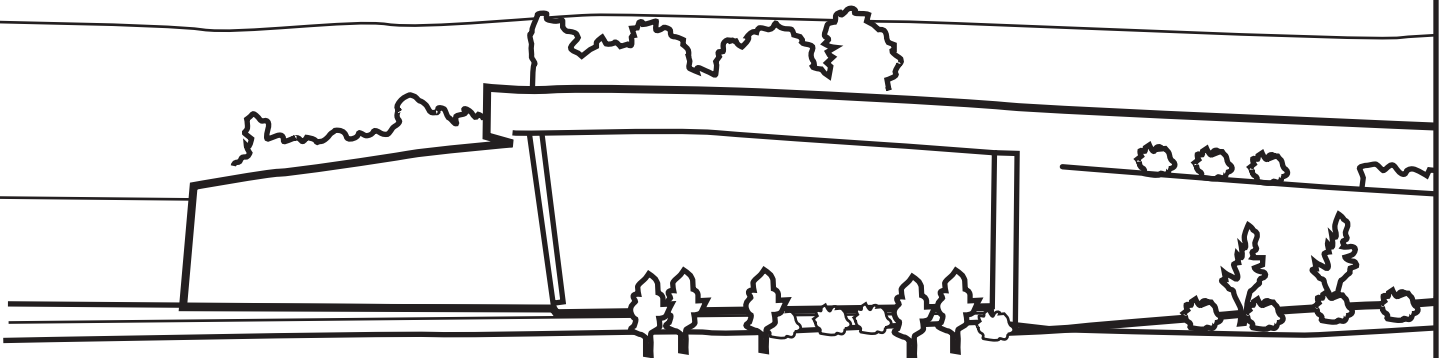

Laundry



Lavender

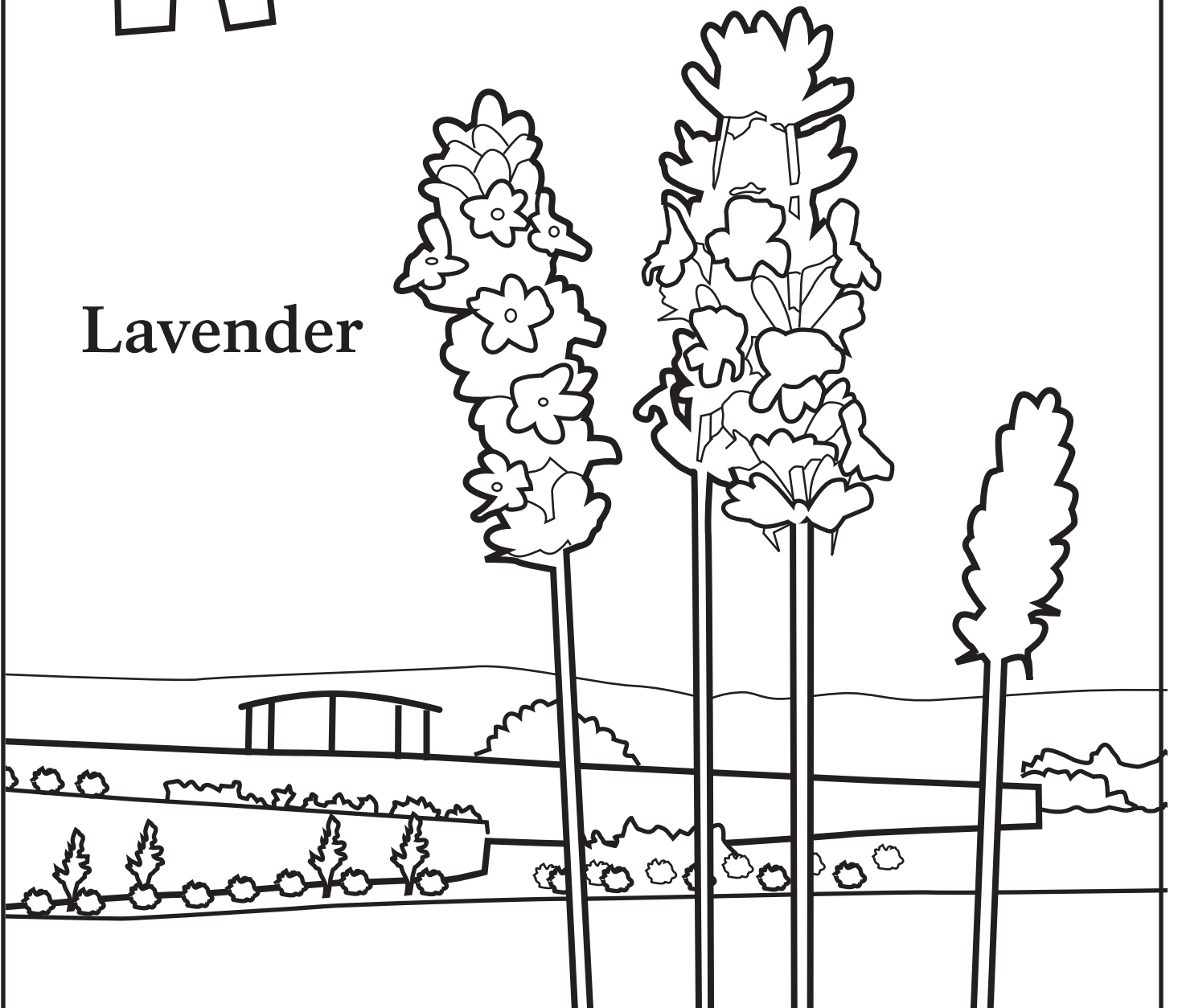

M

is for

Musket

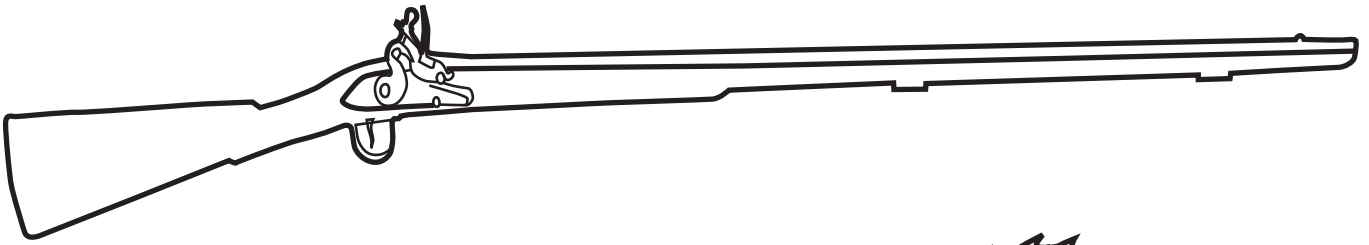

Mint

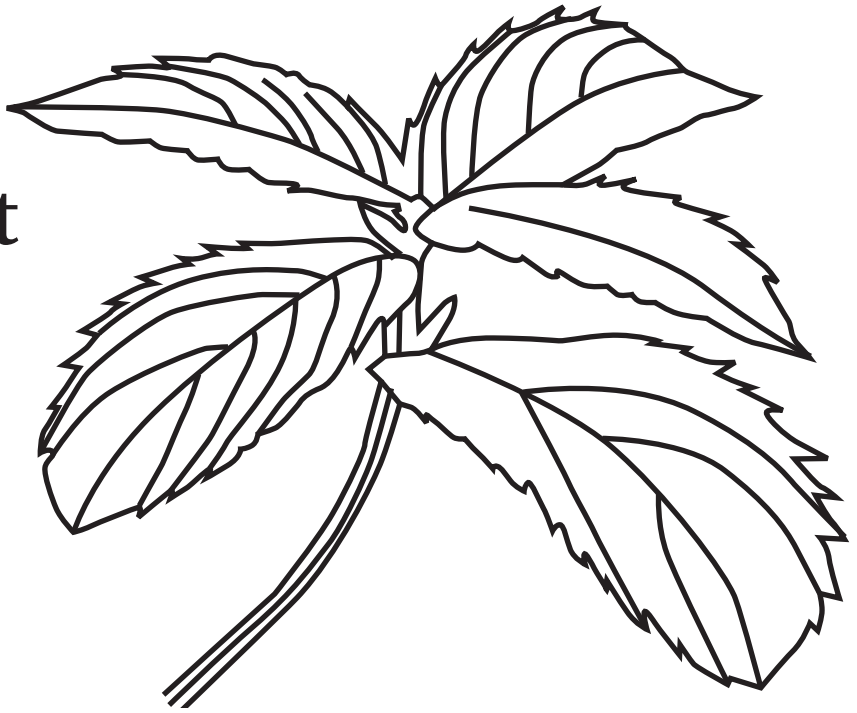

Mountains



N

is for National Parks

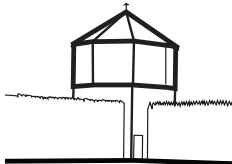

Fort Vancouver



Crater Lake



Ebey's Landing



Klondike



Lava Beds



Lewis and Clark



Mount Rainier



North Cascades



Olympic



San Juan

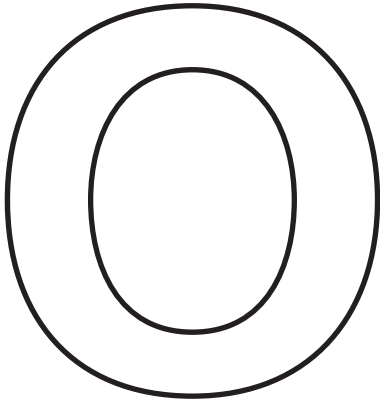

Oregon Trail

is for

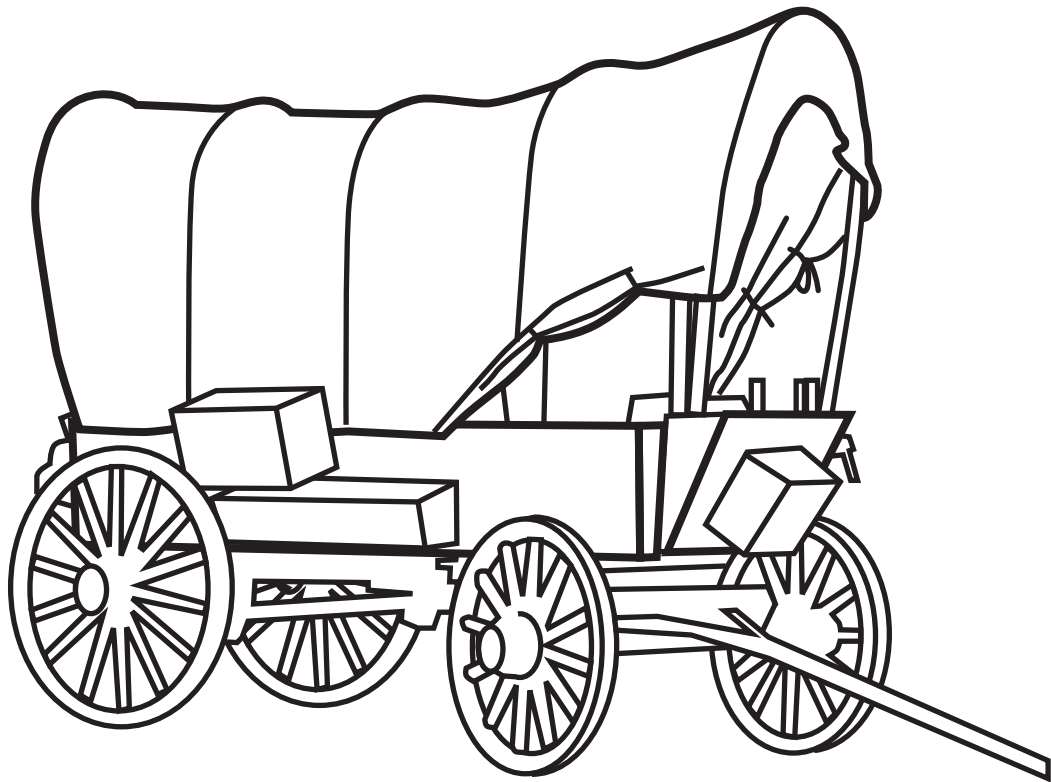

Officers Row



Oregon



Oak Tree



P

is for

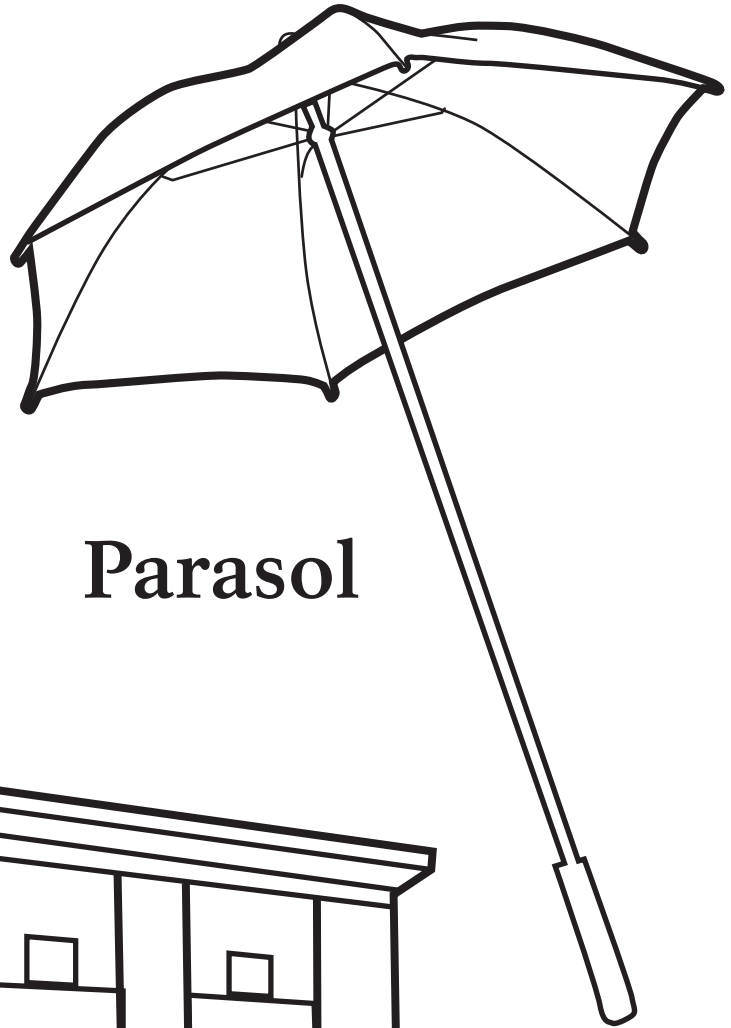

Parasol

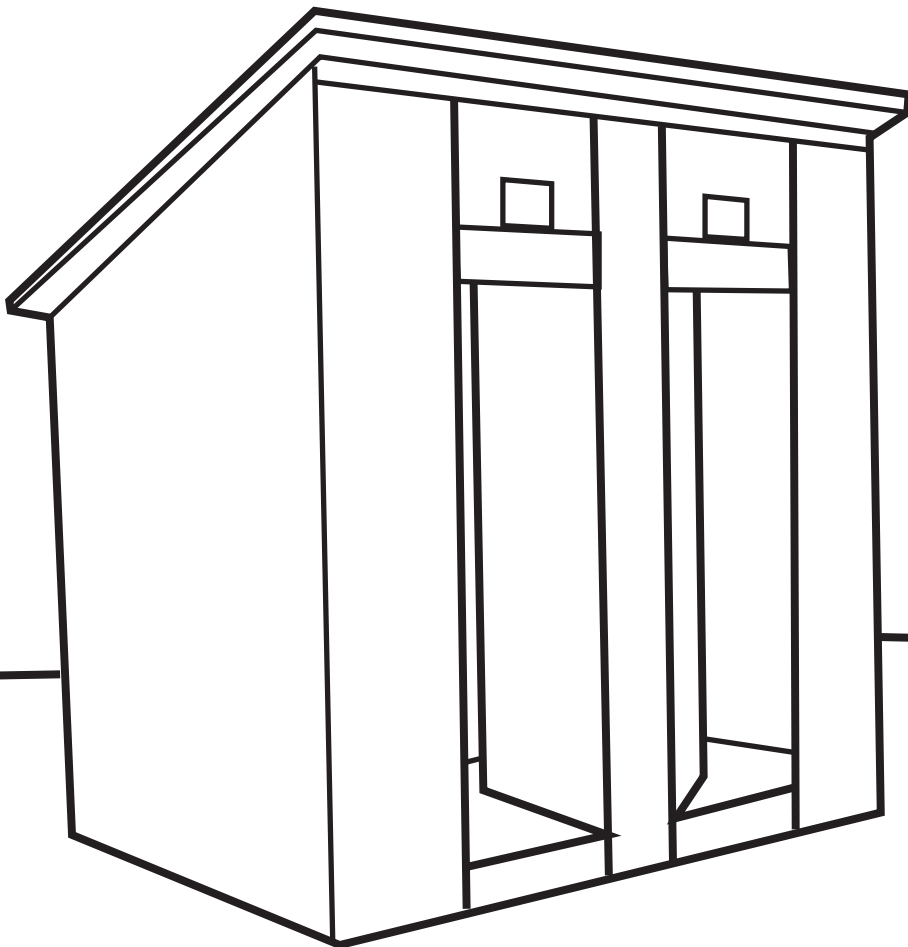

Privy

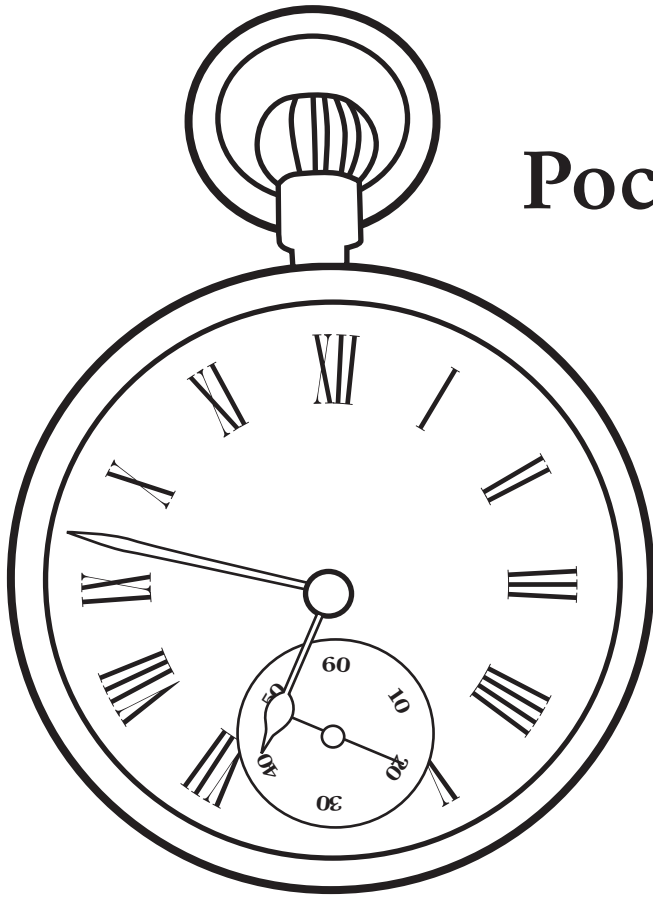

Pocket Watch

Pumpkin

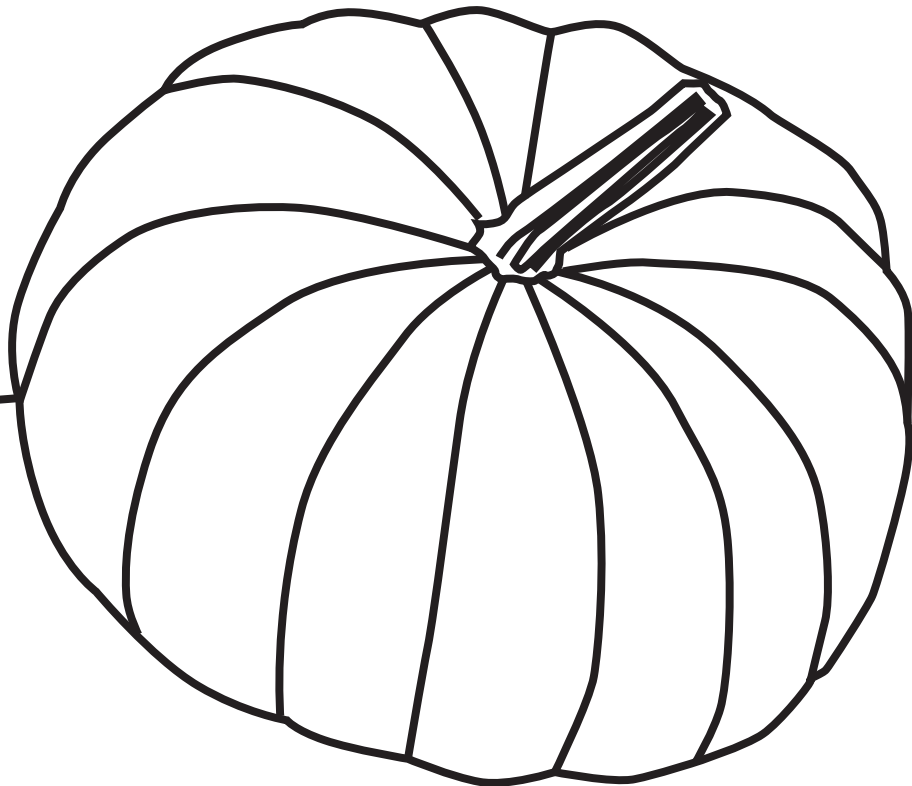



is for

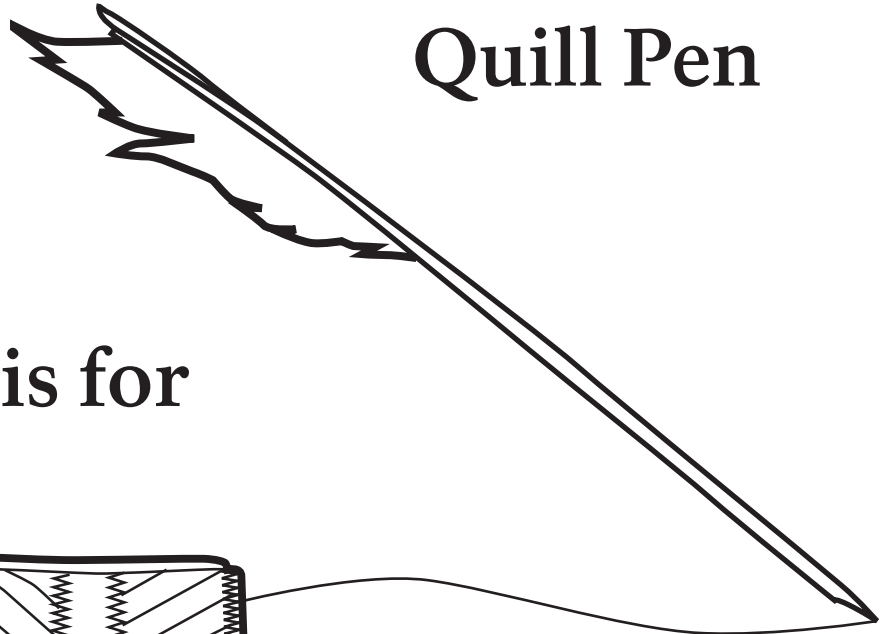

Quill Pen

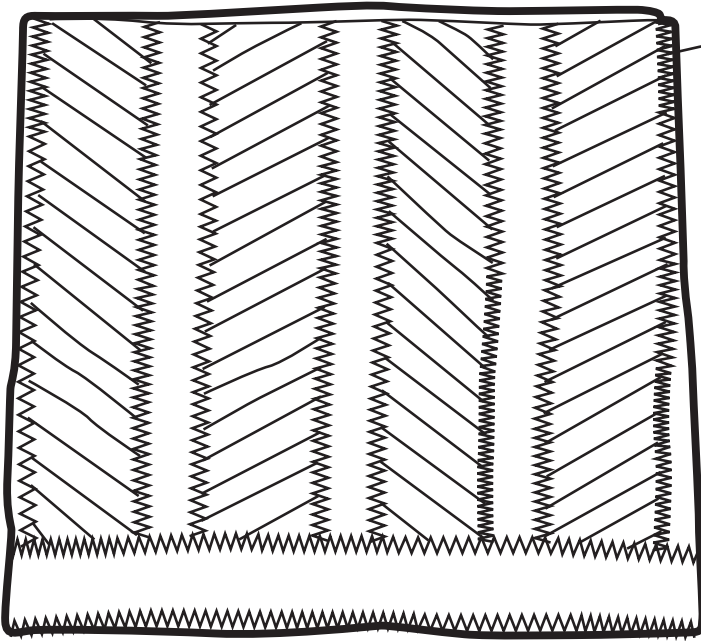

Quilt

Quacking Ducks

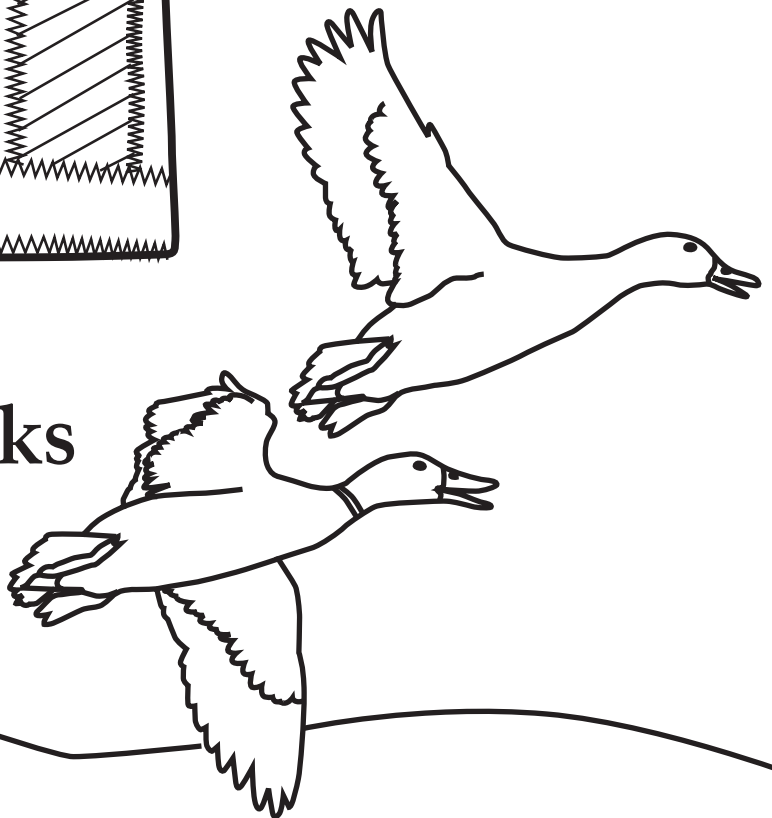

R

Ranger Hat

is for

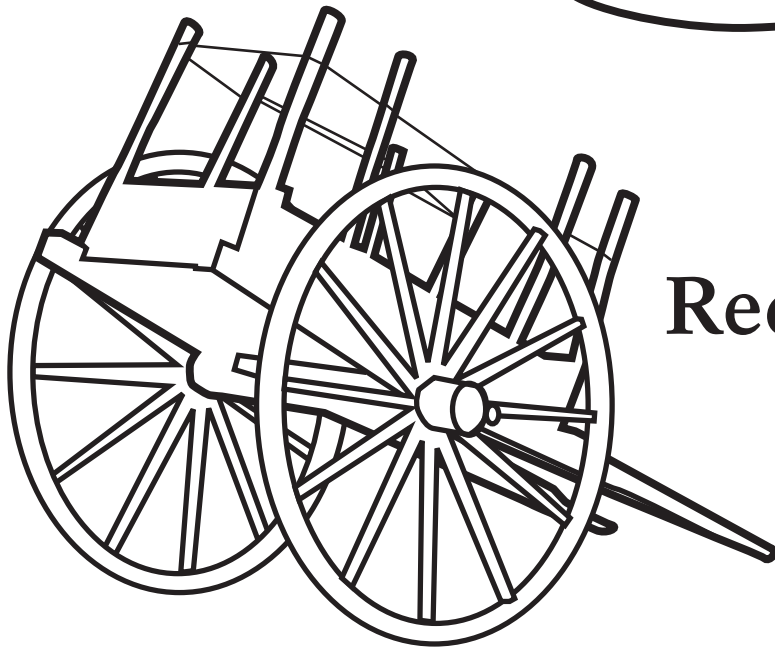
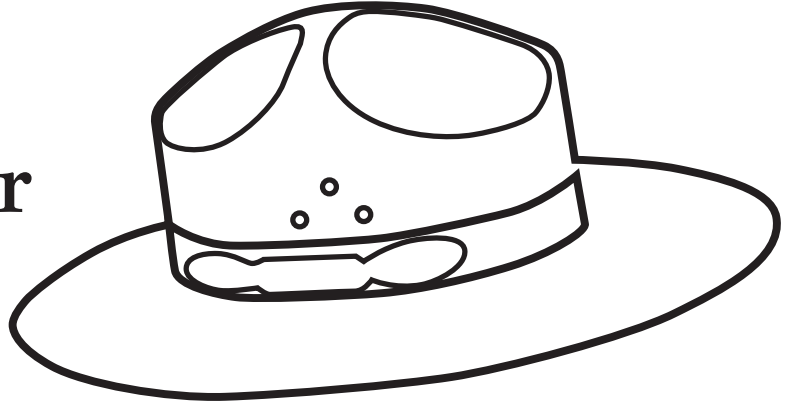

Red River Cart

Railroad

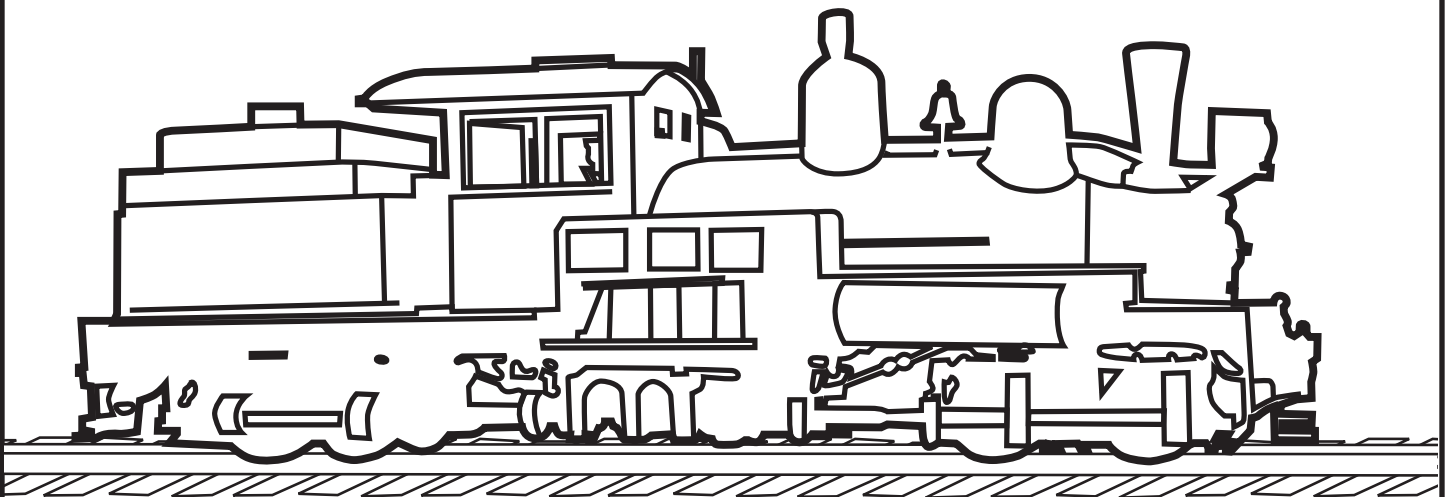

S

Sea Biscuit

is for

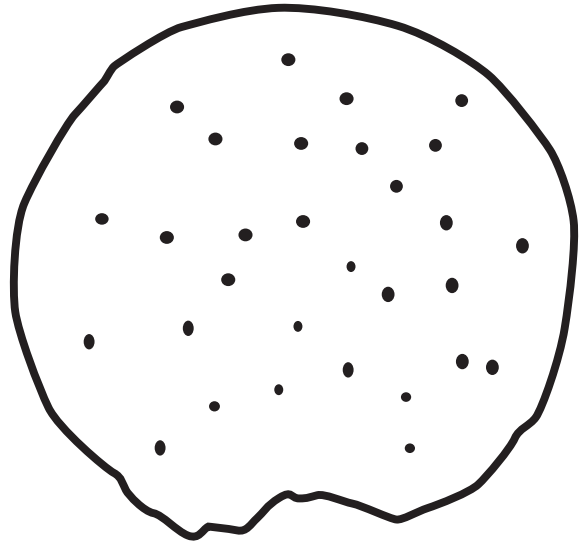

Salmon

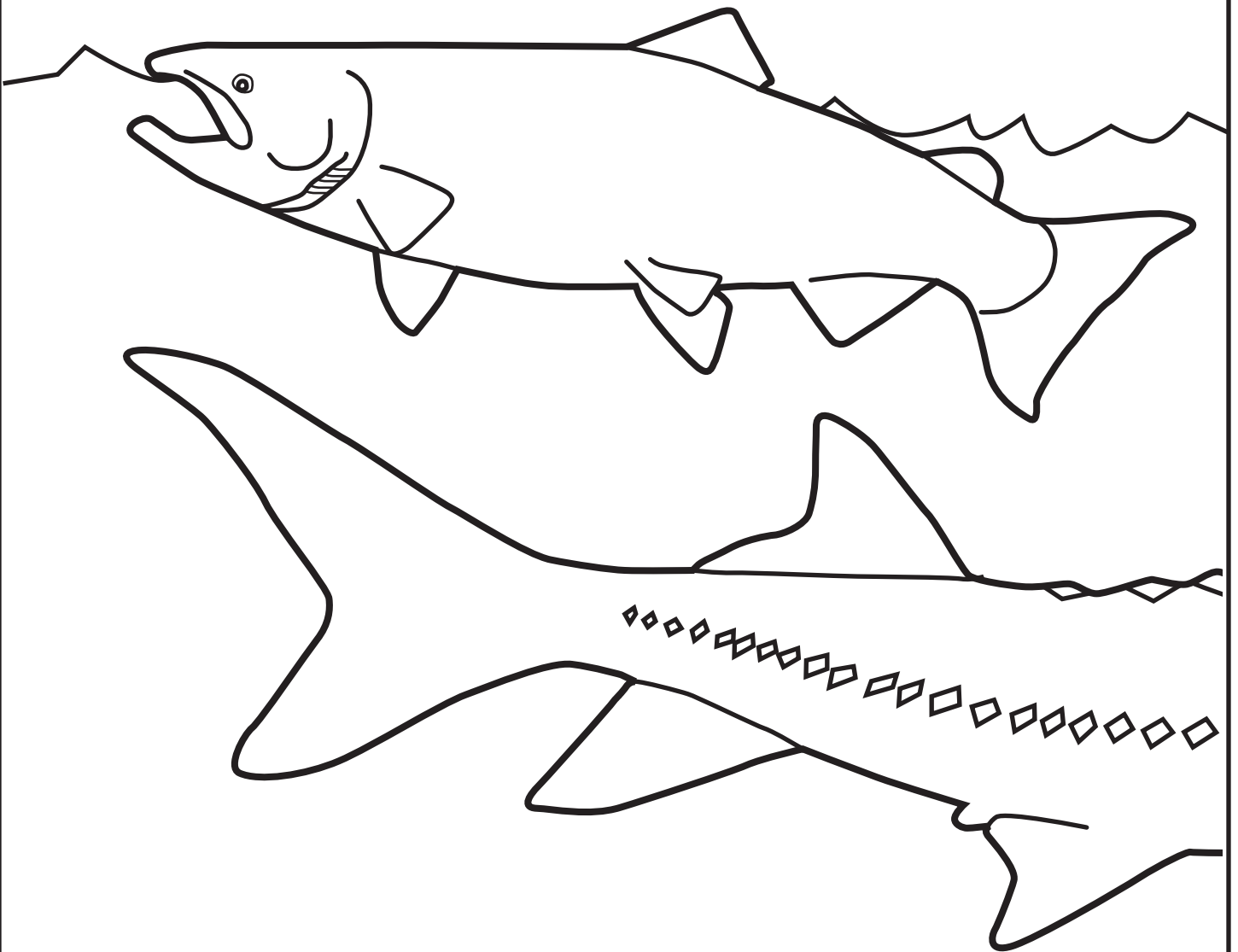

Ship

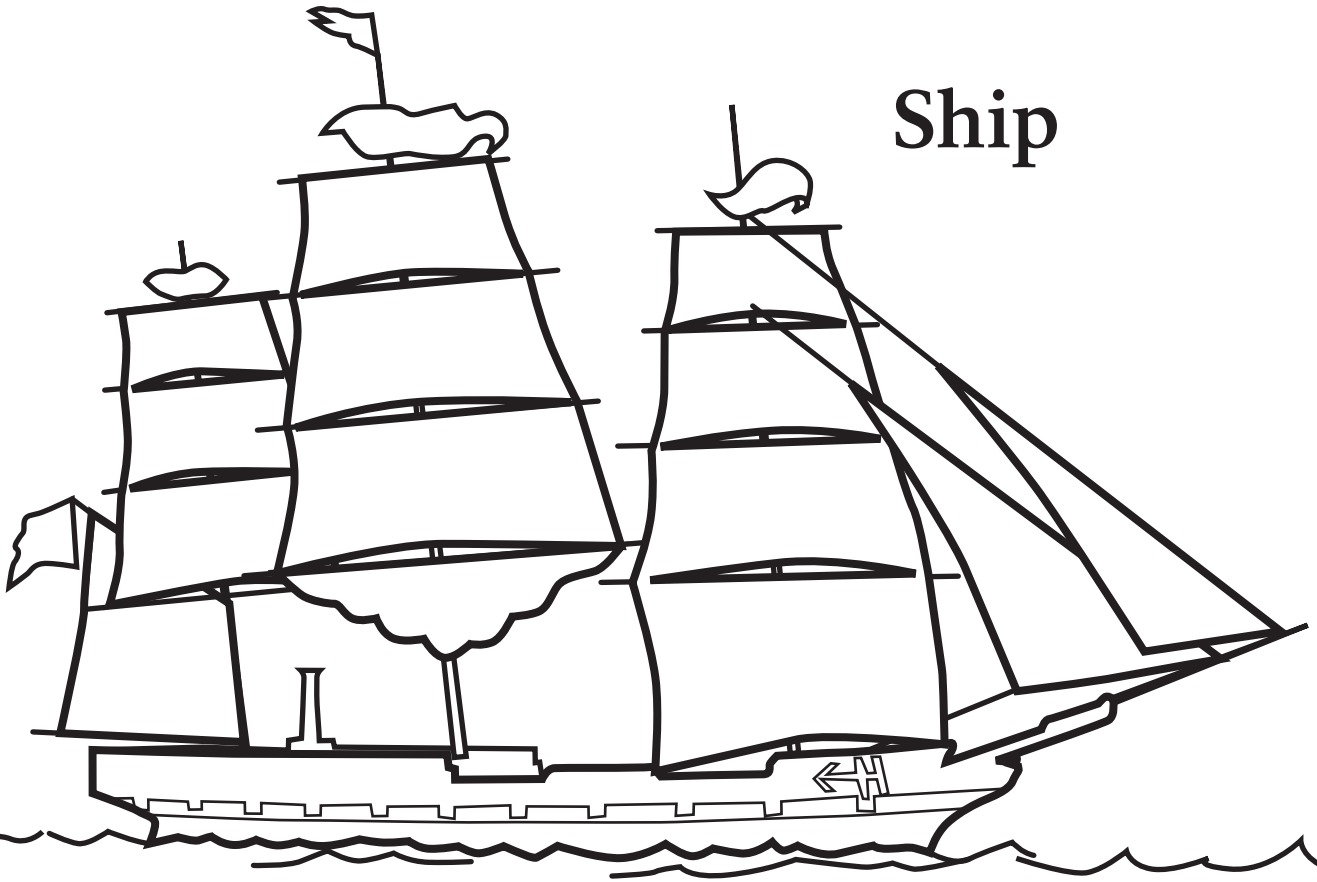

Sturgeon

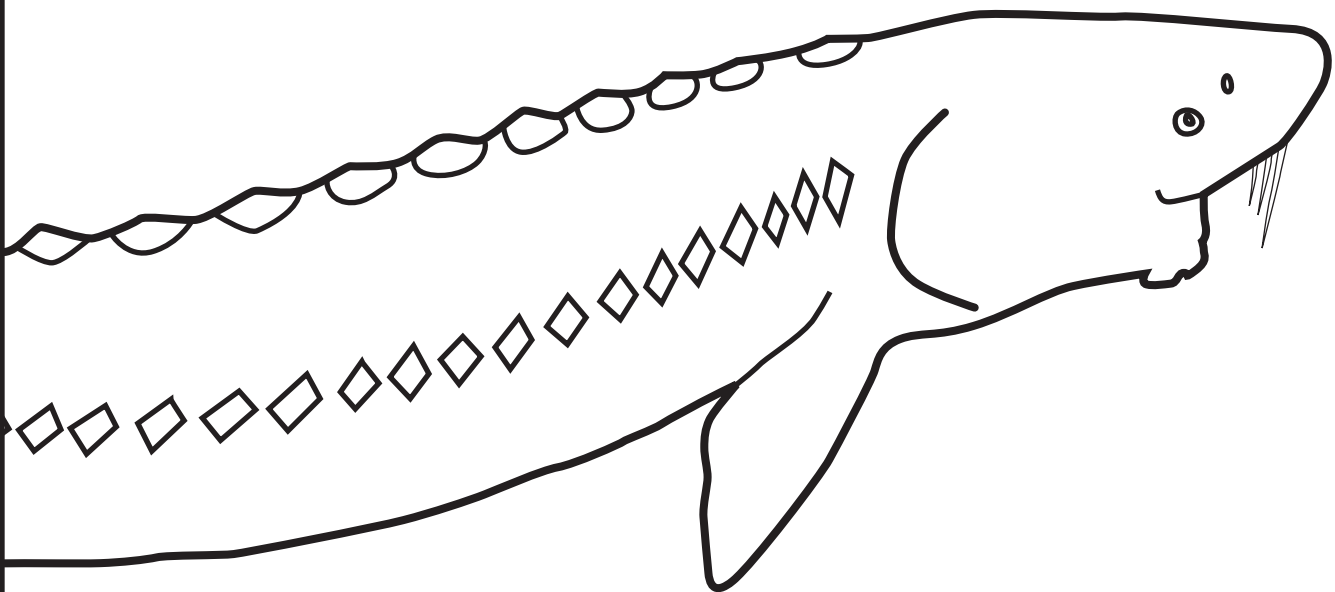

T

is for

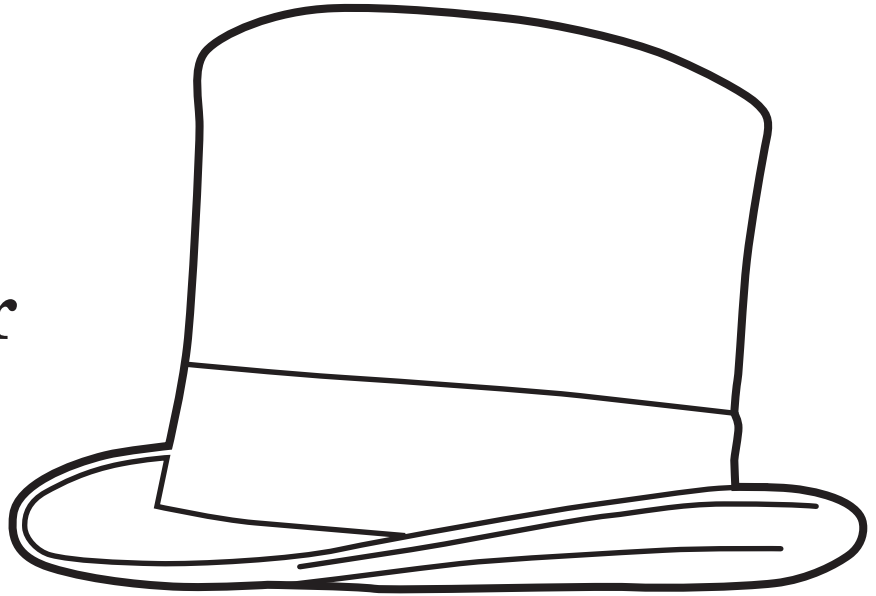

Top Hat

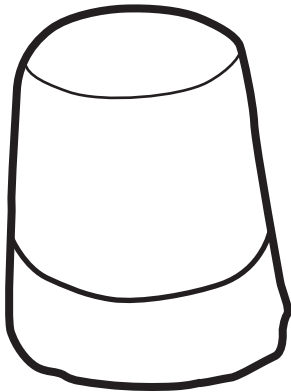

Thimble

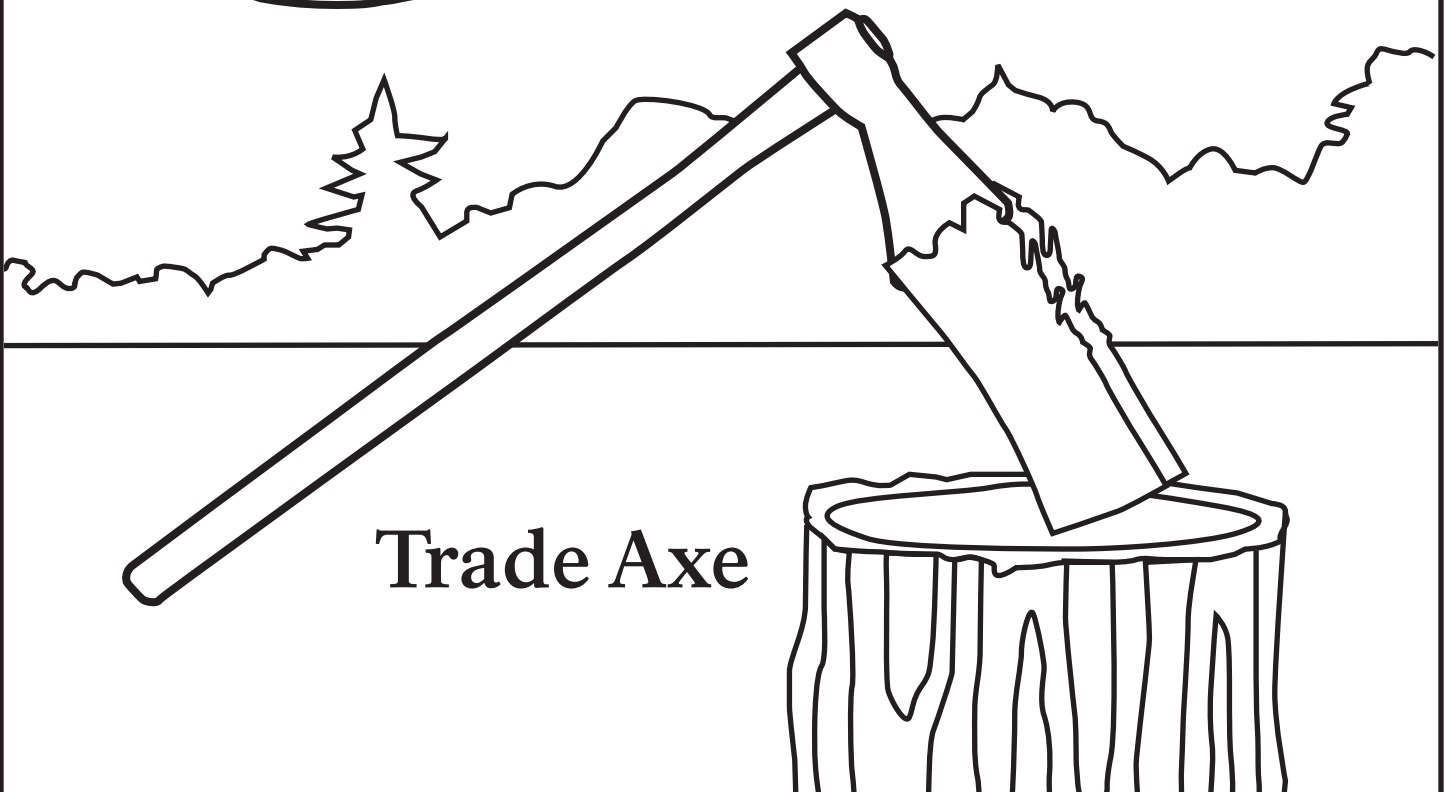

Trade Axe

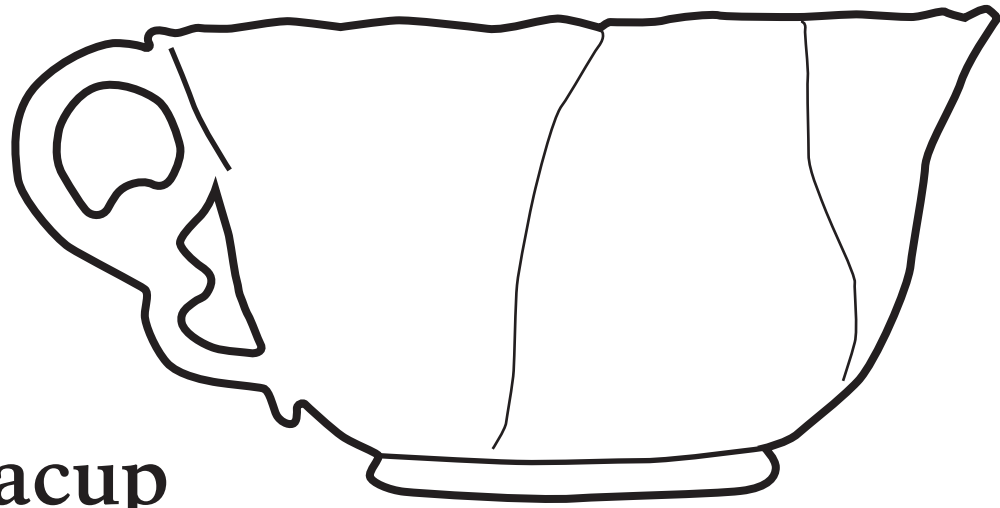

Teacup

Tent

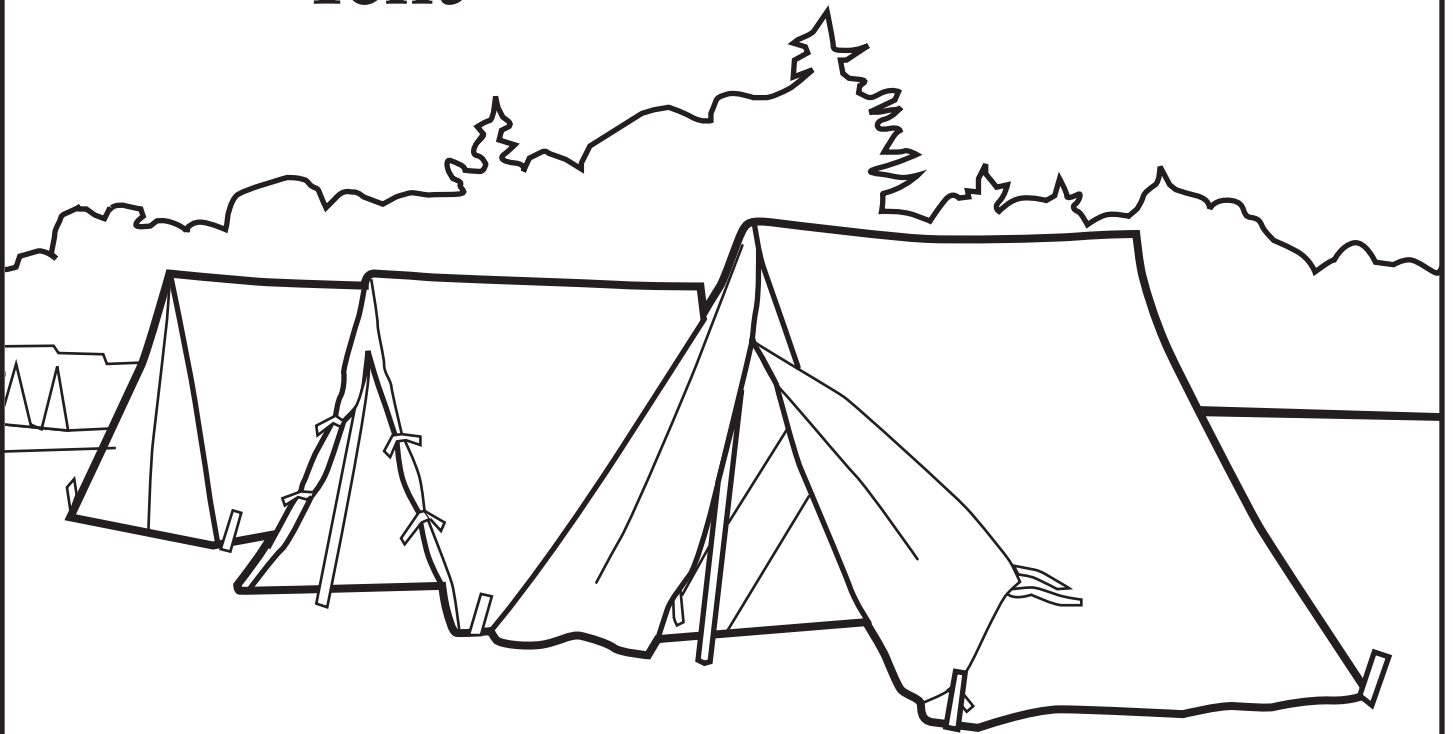

Uniform

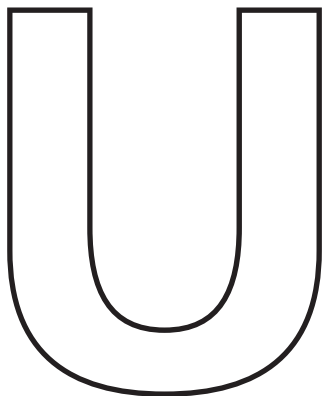

is for

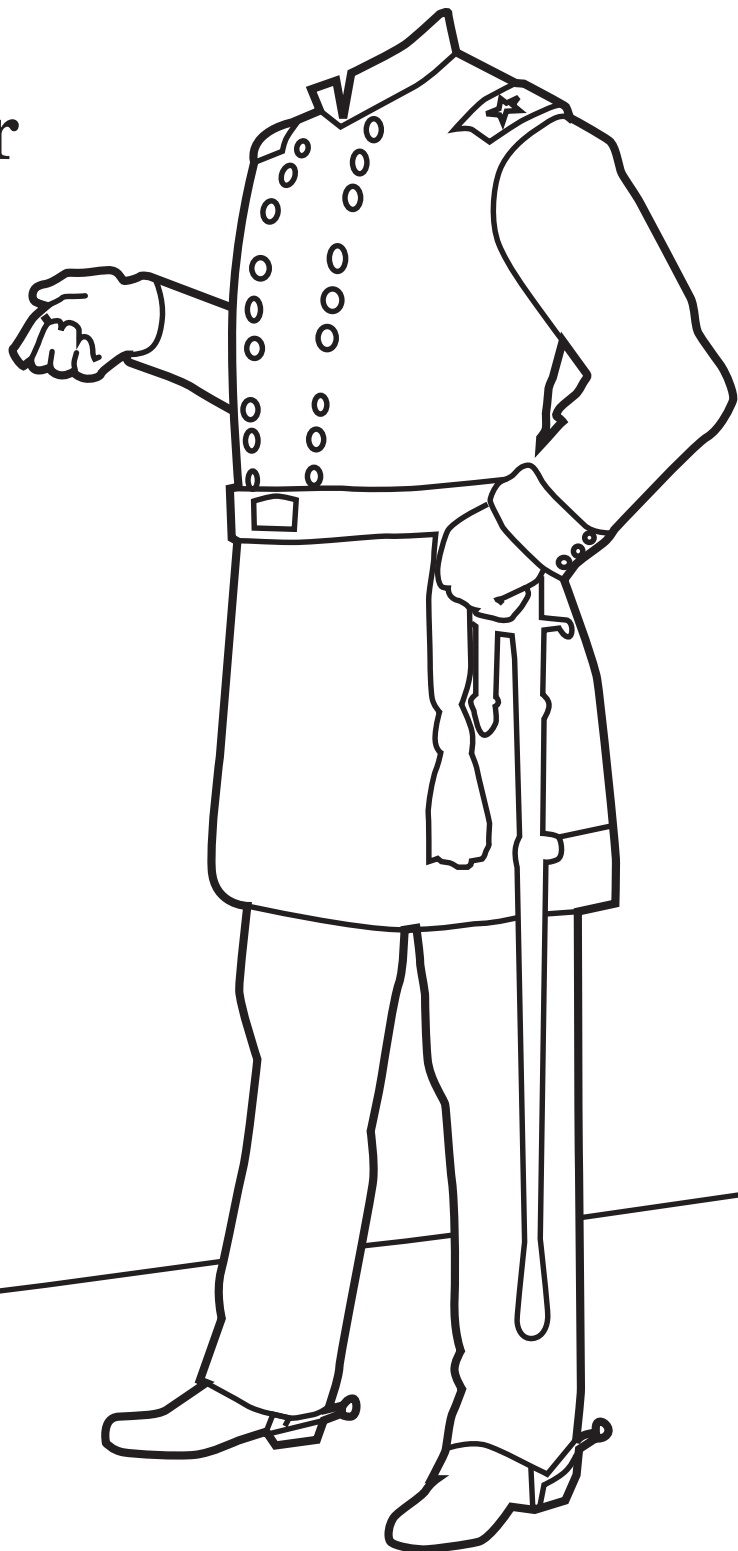

Underwear

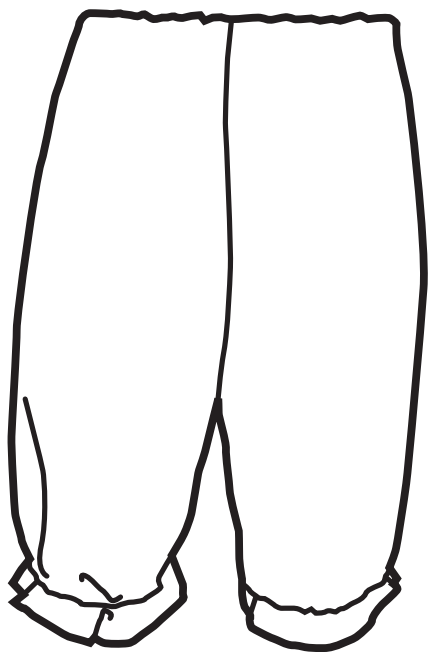

V

Volunteer

is for

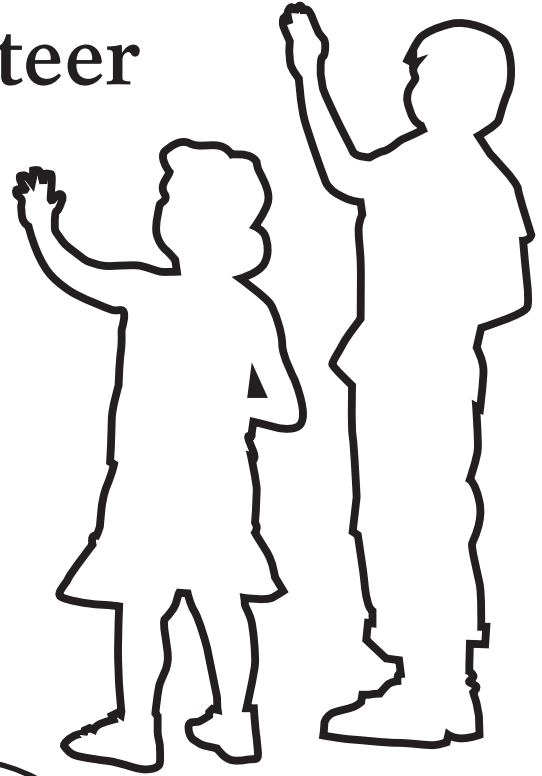

Vegetables



W

is for Washington

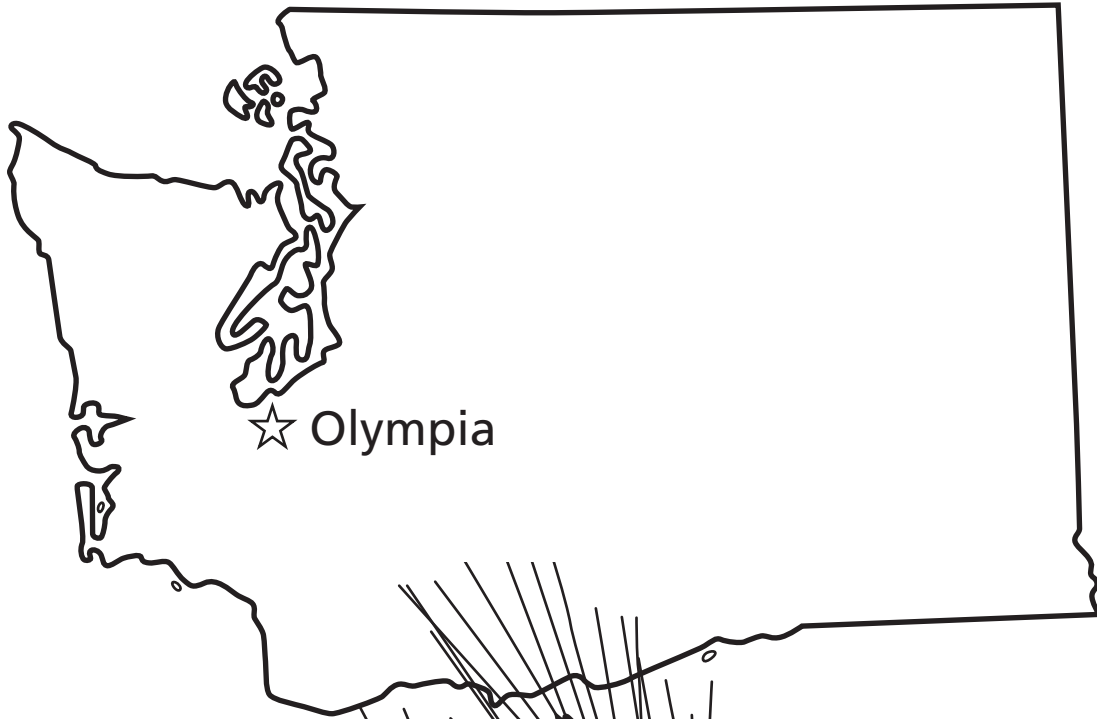

Wheat

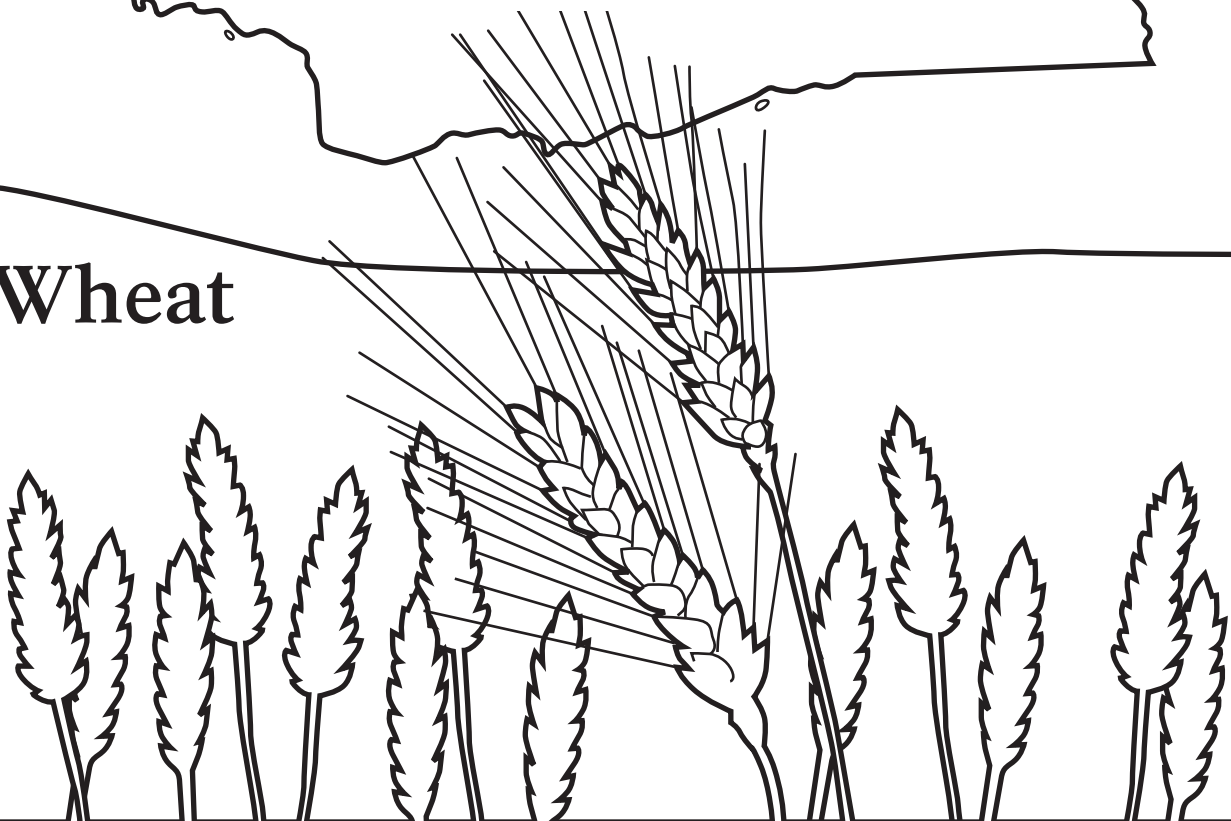

Wapato

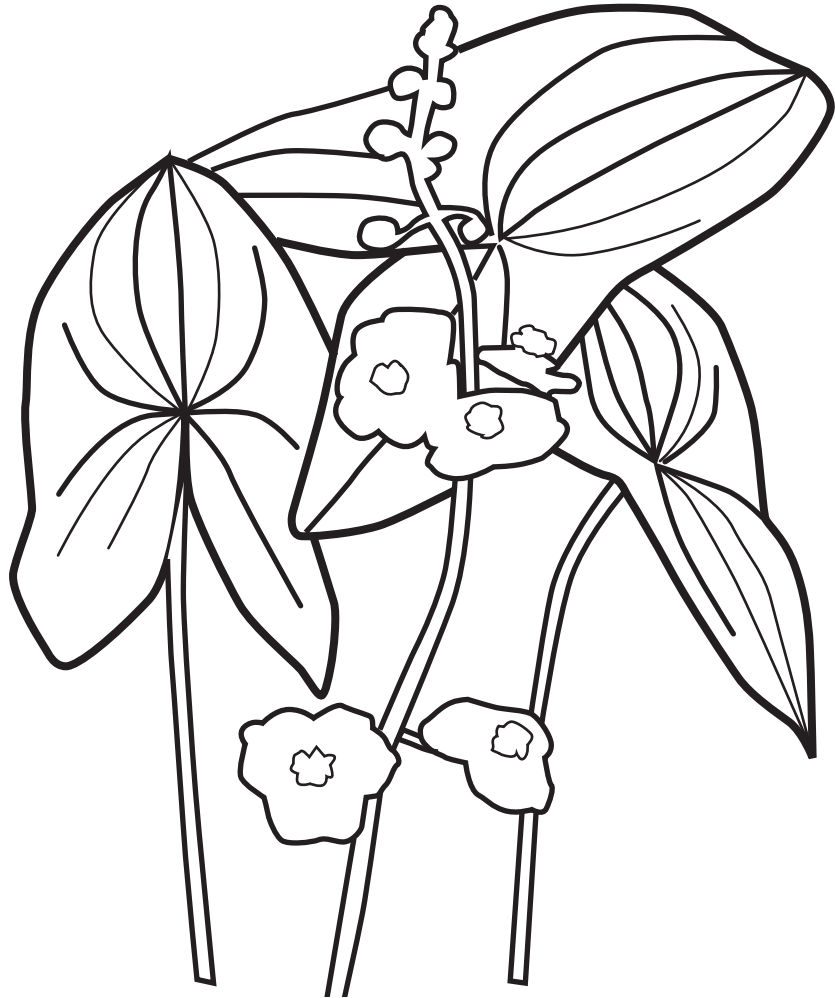

Wharf

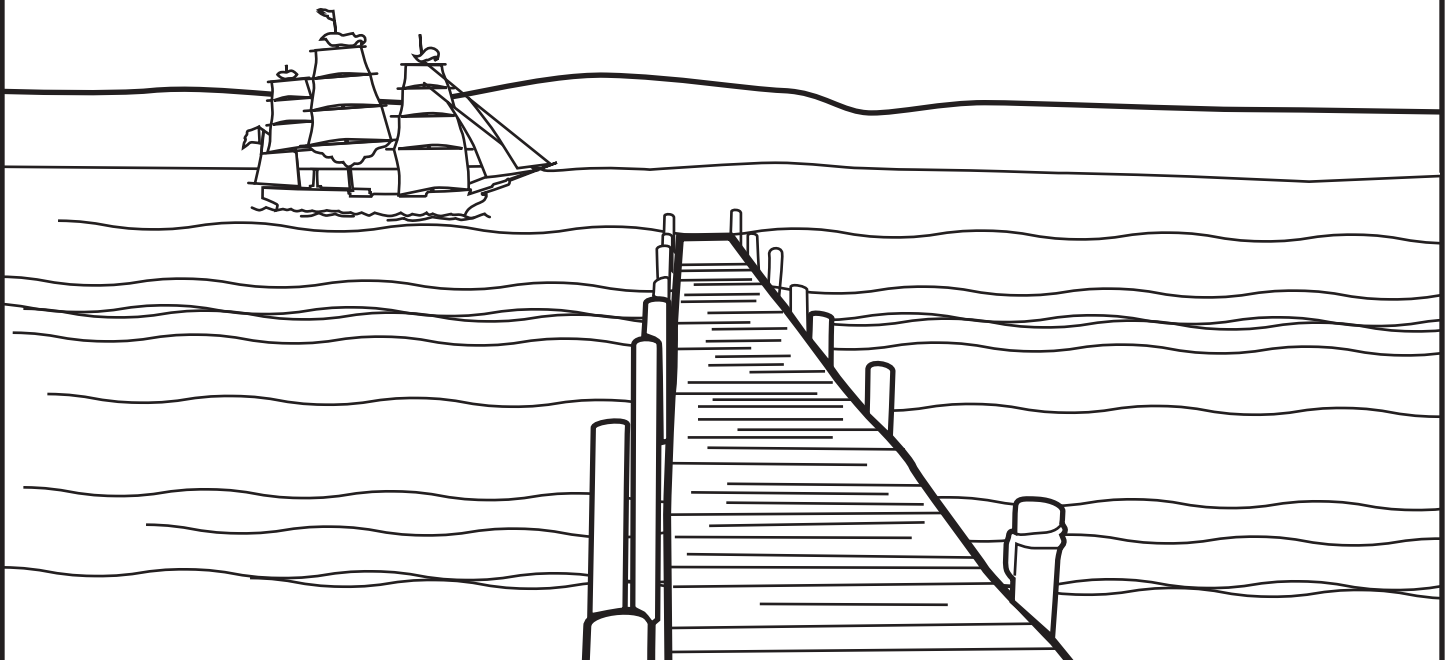

X **Y** is for You
is for
eXtraordinary Place

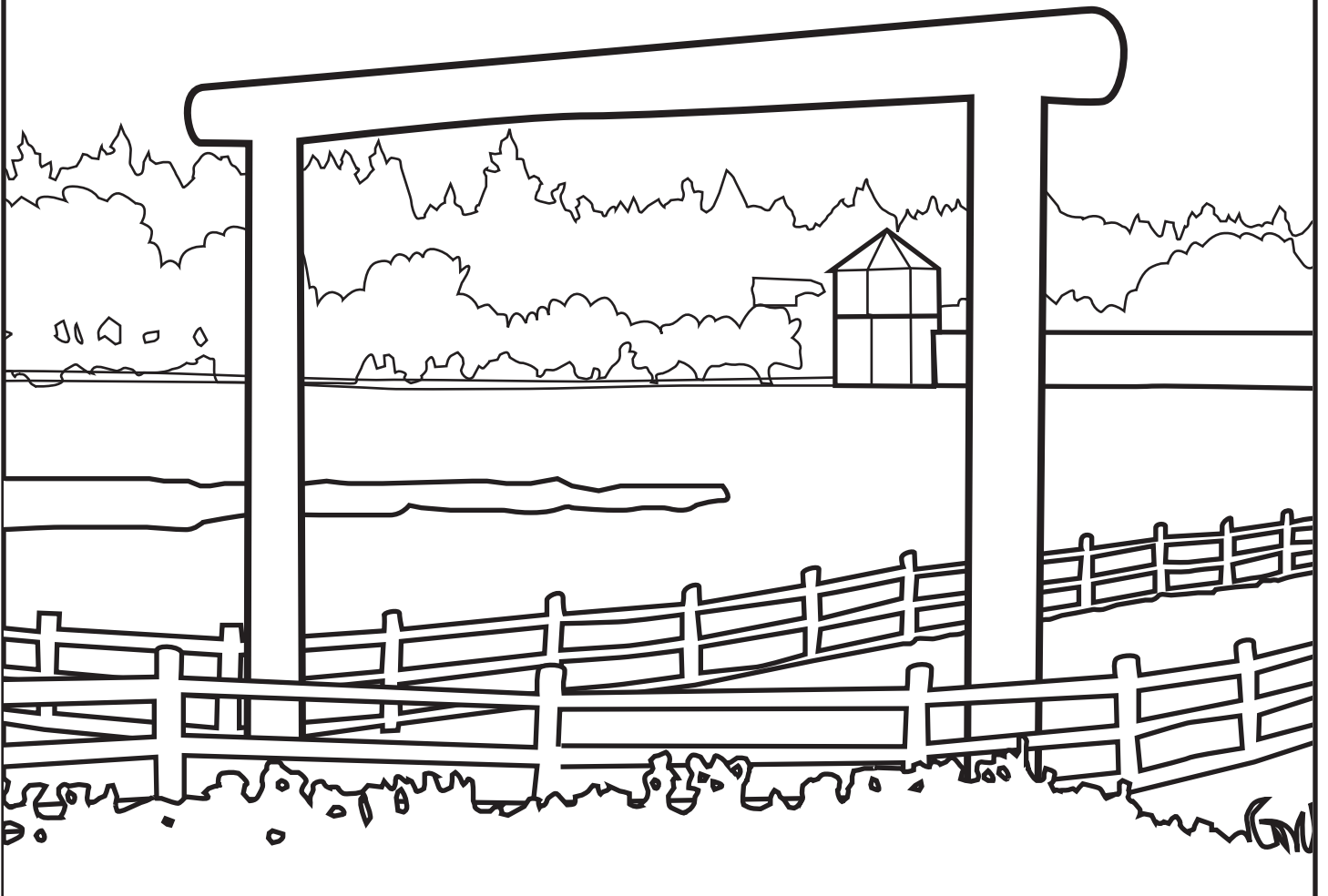
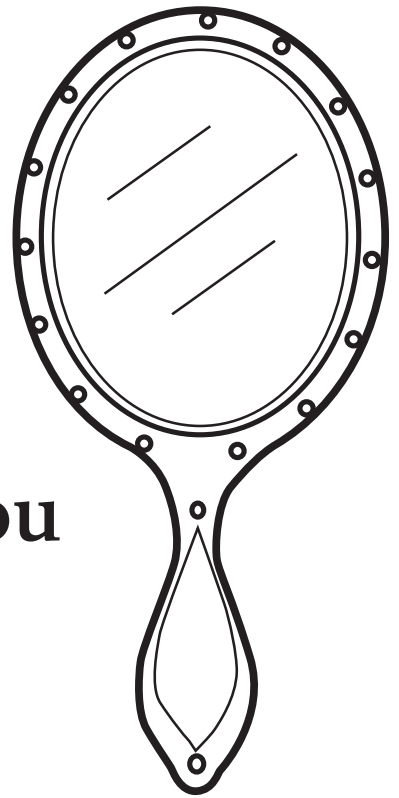

Z

is for Zoom goes the airplane

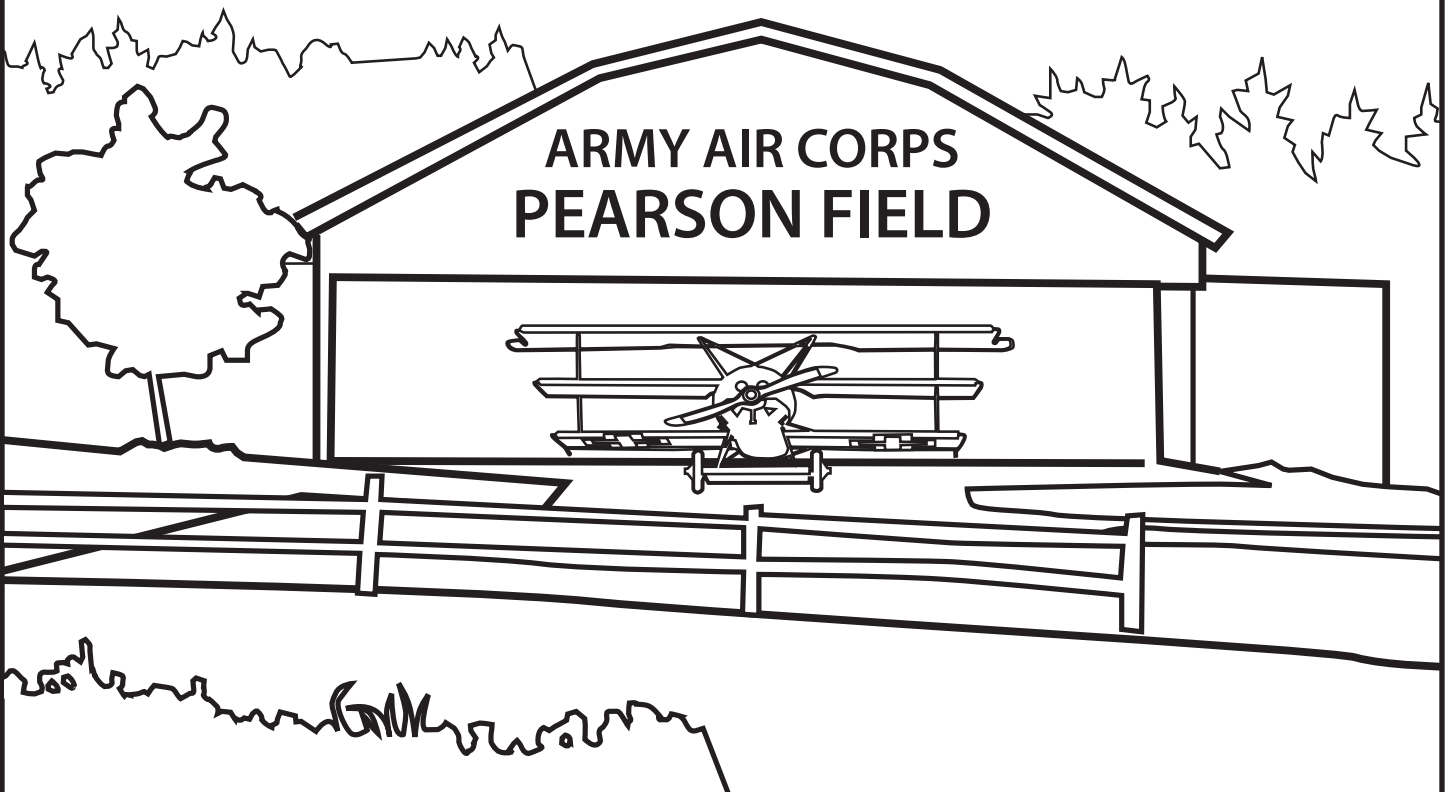
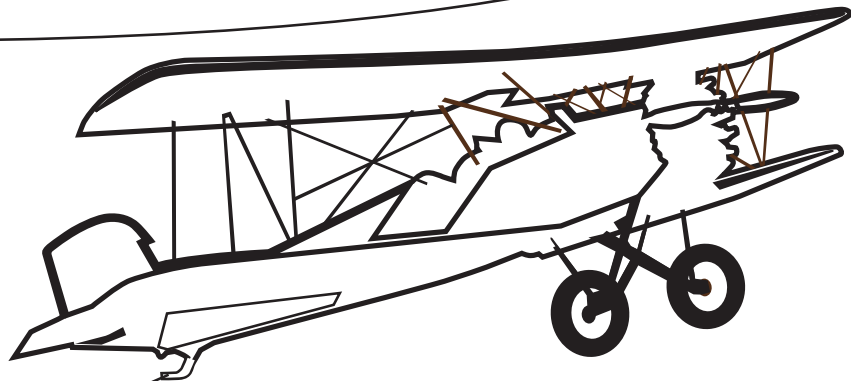

THE
END

The Fort Vancouver ABC's Coloring Book

Welcome to your national park! Fort Vancouver is a very special place where history comes alive! Families can learn about native peoples, Oregon Trail settlers, fur traders, aviators, U.S. Army soldiers, their families, and many others who helped shape the Pacific Northwest.

In this coloring book, young readers will be introduced to words and illustrations that tie to the history of this nationally significant place.

For more information, please contact the Visitor Center at (360) 816-6230 or go to www.nps.gov/fova.



FORT VANCOUVER
National Site